

February 14, 2023

Coordinated Sustainability Strategy

Former Potomac River Generating Station Site
Alexandria, Virginia



Executive Summary

This Coordinated Sustainability Strategy (CSS) for the Potomac River Generating Station (PRGS) site redevelopment outlines holistic sustainability thinking and assesses the feasibility of the strategies and systems to be incorporated in the project. The CSS outlines the pathways to meet the Coordinated Development District (CDD) Sustainability Conditions, but also explores additional measures that the project may incorporate as design progresses and their feasibility is further assessed. This project is committed to sustainability practices aligned with a changing climate while simultaneously providing a vibrant place to live and work woven into the existing fabric of the City of Alexandria.

The CSS lays out a thoughtful set of targets to reduce the development's impact on our planet, improve local environmental conditions and deliver healthy buildings within the Alexandria community. The CSS outlines a roadmap for the five targets in the CDD Sustainability Condition 139. The Sustainability Strategies section explains the contextual background pertinent to the topics of Site, Energy and Carbon, Water, Human Health, and Resilience and identifies additional voluntary targets. The masterplan design team worked collaboratively to provide current industry knowledge, including evaluation of innovative and best-in-class solutions. This collaboration and analysis will continue as each block moves through the design phases.

A reporting dashboard developed for the project will provide transparency as design is finalized and during initial post-completion operations. This future tracking and reporting will provide important information to optimize operations for the long-term viability of the site.

Contents

1. Introduction	4
Powerplant Transformation	
Alexandria Context	
PRGS Development Process	

2. CSS Intent & Structure	9
Overview of Timelines	
Development Phasing	
Roadmap for compliance with CDD Conditions	

3. Sustainability Strategies	17
Site	
Energy & Carbon	
Water	
Human Health	
Climate Resilience	

4. Implementation & Reporting	45
Strategy Implementation	
Reporting Timeline and Dashboard	

5. Appendices	50
Project Phasing & Programming	
CDD Conditions – Sustainability	
Alexandria Green Building Policy	
LEED Preliminary Scorecards	
Clean Energy, RECs & Carbon Offset Pricing	
PRGS District Energy Feasibility Study	



1. Introduction

Hilco Redevelopment Partners (HRP) is proud to submit this Coordinated Sustainability Strategy (CSS) to the City of Alexandria for the redevelopment of the former Potomac River Generating Station (PRGS). HRP reimagines, remediates, and redevelops obsolete industrial sites across the United States. Our redevelopment approach repurposes complex former industrial properties into remediated, resilient, and sustainable developments that generate new economic opportunities. These properties are particularly challenging to redevelop due to the significant upfront investment required to decommission and remediate these sites and the facilities located on them. The PRGS project will transform this former coal-fired power plant into a vibrant, walkable, and sustainable mixed-use development integrated into the surrounding community.

Powerplant Transformation

The project sits on the site of a former coal-fired power plant located in the Old Town North (OTN) neighborhood of Alexandria that was permanently deactivated in 2012 after 63 years of operation. The facility emitted 3.15 million metric tons of CO₂e annually, among other contaminants, or nearly 200 million metric tons of CO₂e over the course of its operation. Concerned citizens hired scientists to study the power plant's pollution, which triggered local and state investigations into the site. Air quality studies found that the plant violated national ambient air quality standards for sulfur dioxide, particulates, and nitrogen oxide. After years of paying non-compliance fines, the plant was officially shut down in 2012 and has sat vacant in the decade since.

Alexandria created a public process to envision the reintegration of this property into the existing neighborhood to maximize its benefits to the local community. The Old Town North Small Area Plan (OTNSAP) details the vision for the former power plant site redevelopment to provide lasting value to the community and City.

HRP acquired the 18.8-acre site from the Potomac Electric Power Company (PEPCO) in late 2020. HRP entered the site into the Voluntary Remediation Program (VRP) administered by the Virginia Department of Environmental Quality (VDEQ) in February 2021 and developed a sampling plan with input and approval from VDEQ and the City of Alexandria. Results from the Fall 2021 sampling were documented in a Preliminary Site Characterization Report that was submitted to VDEQ in March 2022. Further samplings in currently inaccessible areas (beneath buildings, near active utilities) will be performed and documented in a future Site Characterization Report. Locations with concentrations exceeding VDEQ Screening Levels will be further evaluated in a Human Health Risk Assessment which will identify areas for further remediation.



Figure 1. Former PRGS Coal Plant

Alexandria Context

The CSS aims to meet or exceed the City of Alexandria's standards and policies and to align with its goals. HRP's redevelopment of PRGS aims to deliver improved environmental, ecological, and public health conditions, climate resilience and sustainable outcomes – all of which are integral to best practices in climate action. Starting with a remediated site, the project will contribute to economic growth and provide sustainable, high-density housing, while implementing high performance design strategies to reduce per capita greenhouse gas (GHG) emissions from construction and ongoing operations of the development. The following commitments, standards and policies were closely evaluated throughout the development of this document:

Alexandria Green Building Policy



Alexandria's Green Building Policy (GBP) identifies the minimum green building practices for all new development in Alexandria that requires a Development Site Plan (DSP) or Development Special Use Permit (DSUP) and were submitted to City Council on or after March 2nd, 2020. The project will follow the GBP compliance option of LEED certification as the third-party rating system accepted under this policy. The PRGS redevelopment will pursue LEED for Neighborhood Development and LEED for Building Design + Construction Silver, at a minimum. The current version of the GBP at the time of writing the CSS is included in the Appendix.

Old Town North Small Area Plan



The OTNSAP was adopted in 2017 after a robust planning and community engagement process. The OTNSAP presents community goals for the redevelopment of the former PRGS site into a mixed-use district to act as an economic anchor that incorporates local arts and innovative sustainability targets. It outlines Eco-District sustainability strategies under four categories:

- Water Quality
- Energy & Green Building
- Design, Land Use and Transportation
- Performance Measures

The OTNSAP envisions four specific measures for the former power plant site to serve as a model for sustainability:

- Achieve LEED ND Silver
- Develop a Sustainability Master Plan (Coordinated Sustainability Strategy)
- Strive for carbon neutrality targets
- Explore the use of district energy on the site

Document link: [OTN Small Area Plan](#)

Climate Emergency Acknowledgement

In October 2019, the Alexandria City Council adopted a resolution declaring climate emergency. This declaration acknowledged the grave threat that climate change poses to everyone in Alexandria and in the world. This resolution emphasizes the City Council's commitment to climate change action.

Document link: [Alexandria City Council Declares Climate Emergency](#)

City of Alexandria Environmental Action Plan 2040

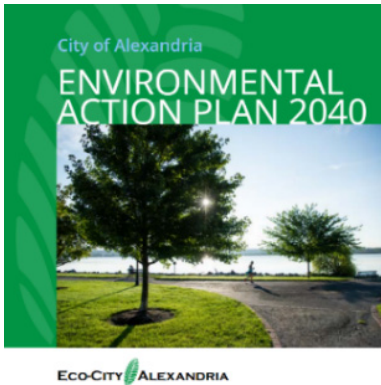

Alexandria's Environmental Action Plan (EAP) 2040 adopted in 2019 as an update to the original EAP 2030 with expanded recommendations and commitments. It is a strategic guide that builds on the principles of the City's Eco-City Charter and identifies 19 goals with targets for short-term, mid-term, and long-term actions within the policy's ten guiding topics. The EAP 2040 commits to updating the document every five years.

Document link: [Environmental Action Plan 2040](#)

It is noted that the City of Alexandria is also currently working on an Energy and Climate Change Action Plan (ECCAP) which will provide a roadmap to accelerate reductions in city-wide GHG emissions and adapt to the most pervasive impacts of climate change within the City. Strategies across five sectors – buildings, renewable energy, transportation, waste, and other outline a possible pathway for the City to achieve carbon neutrality by 2050. The current plan available for review at the time of writing the CSS is a draft for public comment as of January 2023.

Document link: [ECCAP Draft](#)

Eco-City Charter

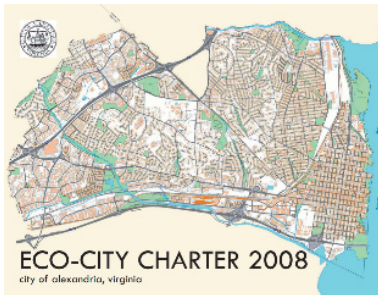

Alexandria's Eco-City Charter was adopted by City Council in 2008 to define the City's commitment to ecological, economic, and social sustainability. The Charter outlines 11 guiding principles that reflect goals established in Alexandria's 2015 Strategic Plan and form the basis for the City's Environmental Action Plan 2040.

Document link: [Environmental Charter](#)

PRGS Development Process

The approval of the CDD for the PRGS redevelopment included specific conditions to be met. During the review process, HRP voluntarily developed a framework to target carbon reduction measures in the Carbon Neutrality Analysis (CNA). The CNA provided early analysis to influence design across site, buildings, and operations contributions to operational and embodied carbon.

CDD Sustainability Conditions

Several of the CDD conditions relate to the project's sustainability targets and ambitions. These conditions are summarized below and referenced throughout the CSS, with full text also provided in the Appendix.

Condition	Topic	Summary
Condition 139	Carbon Neutrality	Site and buildings shall seek to achieve carbon neutrality through 5 targets: building operational carbon reduction, on-site renewable energy generation, building embodied carbon reduction, electric systems, and off-site renewables.
Condition 143	Green Building	Comply with the Alexandria GBP in effect at time of DSUP submission.
Condition 144	Coordinated Sustainability Strategy	Develop a CSS prior to 2 nd concept Infrastructure Development Site Plan.
Condition 145	Coordinated Sustainability Strategy	Outline strategies for site and building targets including energy and carbon planning, indoor environmental quality, site, public realm/streetscapes, water use management, waste management, resilience, and reporting.
Condition 149	Electrification	Demonstration compliance with electrification implementation as outlined in the EAP 2040 targets, goals, and actions.
Condition 150	Electrification	Off-street parking shall provide EV charging consistent with City policies at time of DSUP submission.
Condition 151	On-site Energy Generation	Newly constructed buildings shall be utilized to provide on-site energy to the extent feasible.
Condition 152	Construction Waste	Provide regional construction recycling and reuse guidance with each final site plan.
Condition 153	Reporting	Site-wide sustainability performance shall aggregate individual building data annually as buildings are constructed.
Condition 154	Reporting	Public benchmarking through Energy Star Portfolio Manager results for each new building shall be submitted.

2. CSS Intent & Structure

The OTNSAP outlined a Sustainability Master Plan, now renamed the CSS, to identify strategies that could be implemented across phases of development that will integrate progressive goals and targets. This CSS identifies the pathways for achievement of the five performance targets included in the CDD, provides an overview of sustainable strategies and targets, and defines the ongoing reporting process and tracking dashboard outlined in the CDD. This process is intended to increase transparency and reporting of sustainability outcomes for the project.

This document is based on best available information at the time of writing relative to the current state of project design and planning and available technologies. Decision making for the PRGS redevelopment will occur across multiple phases and design submissions, as further detailed within this section. Strategies will continue to be studied at the applicable site and/or block level as design progresses. Within Section 3. Sustainable Strategies, each sub-strategy will outline these strategies, with project targets listed at the end.

Overview of Timelines

The CSS provides an overview of sustainability considerations, key strategies, and targets for implementation. The application of strategies over the short-, mid- and long-term is dependent on the pace of growth and development of evolving technologies in the sustainability field. Significant federal investment and research is still needed to support the shift of emerging technologies to being market ready for technical reliability and financial feasibility. Federal policies like the 2022 Inflation Reduction Act (IRA) and the 2021 Infrastructure Bill support and drive advancement of emerging sustainability technologies, and support initiatives like domestic manufacturing, job creation and investing in marginalized communities. The use of government incentives will be analyzed and utilized if determined to align with the project program and is financially and technically feasible. Further information on these policies is addressed in the financial feasibility section later in this chapter.

Each Sustainability Strategy section of this CSS outlines market-ready, innovative, and emerging solutions at the time of this report. Future phases of the project will have this as a reference point to benchmark progress and re-evaluate opportunities that were not yet feasible in early phases. The timelines established for the CSS are intended to inform the long-term ownership and operations of the PRGS redevelopment site, to guide planning for future solutions and ongoing updates for later phases of the project as defined below:

Short-term (2022-2026)	Mid-term (2027-2031)	Long-term (2032 onward)
<ul style="list-style-type: none"> • Analysis of market-ready solutions for site and block DSUPs submitted in this timeframe • Evaluate and coordinate with external parties required for approvals – local utilities, adjacent property owners, City officials • Establish project sustainability targets for design and construction for site and block DSUPs submitted in this timeframe 	<ul style="list-style-type: none"> • Analysis of market solutions that were previously innovative or emerging technologies for block DSUPs submitted in this timeframe • Measure and report existing building performance per CDD requirements • Update project sustainability requirements for design and construction for site and block DSUPs submitted in this timeframe 	<ul style="list-style-type: none"> • Review and respond to external factors that influence achieving targets (electric grid emissions, weather data) in line with operational procedures • Measure and report existing building performance per CDD Condition 155 • Track system performance as systems approach end of useful life

Development Phasing

The PRGS development will transform the location from a closed-off former industrial site into a vibrant, urban, mixed-use community that will include office, residential, arts, hotel, entertainment, retail, and restaurant use. The property will be reconnected to the surrounding Old Town North neighborhood through the extension of the existing street network and the seamless integration of new publicly accessible parks with existing and future public open space. The site will be accessible through public transportation, the pedestrian and bicycle network, and will engage the adjoining uses and buildings, offering Alexandria the ability to showcase forward thinking urban and sustainable planning and development.

The CDD created three phases for the redevelopment of the PRGS site which outline when infrastructure and publicly accessible open space will be delivered, as shown in Figure 2. Phased redevelopment will occur by block; development is anticipated to start at the southern end of the site and the pace of redevelopment will be driven by market conditions. At the time of this writing, HRP has submitted Concept 1 DSUPs for Blocks A, B, and C, which include a building program mix of approximately 80% residential and 20% commercial space (including office, retail, restaurant, and potential cultural space).

Mixed-use development is a cornerstone of smart growth principles, and combined with the provisioning of outdoor space, yields benefits across multiple dimensions of sustainability, ranging from emission reductions to promoting positive health and well-being outcomes.¹ The co-location of residences, work, retail, restaurant and other leisure use programs with outdoor spaces helps to create vibrant, attractive communities with greater social diversity and economic strength, while simultaneously helping protect the environment and natural resources. Mixed-use development can enhance a sense of community and perceptions of security by increasing the number of people and activities that occur along the streetscape, which further helps to attract more pedestrians, thus enhancing community vitality. The co-location of

different uses also helps reduce automobile reliance, as individuals have access to a wider range of amenities within walking distance; downstream impacts of this reduced automobile reliance include fewer carbon emissions from vehicle travel (operational carbon) and reduced parking infrastructure (embodied carbon).

Co-location also has benefits for businesses, creating greater client access in a smaller catchment area. The inclusion of outdoor recreation and leisure spaces helps further contribute to community vitality and provides community members with health and well-being benefits associated from physical activity and connectivity with nature. Additionally, increased site green space, combined with reduced parking hardscape, can better manage rainwater, reducing runoff into local waterways or burdens on stormwater infrastructure; increased green area can also combat the localized formation of the urban heat island, which contributes to greater human health and comfort and reduced building cooling loads. These complete and connected urban strategies allow users to make sustainable, healthy, and low impact lifestyle choices.

For a development of this size and scale, the phased implementation will also allow for detailed review of strategies at each block. This allows the project to make the best use of finances available at each phase, to learn from early implementation for future efficiencies and technological advancements, and to take advantage of future incentives or pricing not currently available.

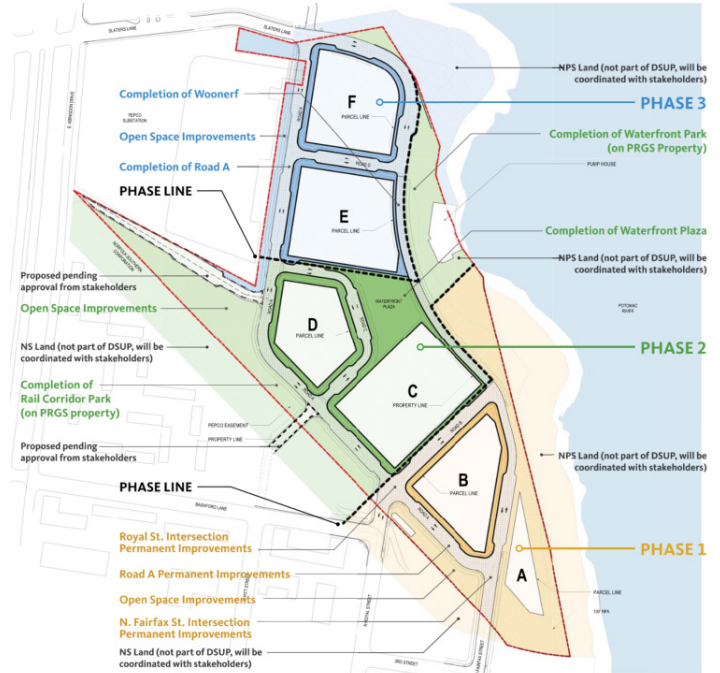

Figure 2: PRGS Development Phasing

¹ Further information on “Smart growth” is available at: <https://smartgrowth.org/smart-growth-principles/>

Roadmap for Compliance with CDD Carbon Neutrality Conditions

Target 1 – Operational Carbon Reduction

Site-wide



Operational carbon reduction opportunities at the site level are considered in the district energy feasibility analysis to evaluate the efficiency of shared heating and cooling loads across the development. Space availability, increased infrastructure and materiality, embodied carbon costs, efficiency improvements and total cost of ownership factors will define feasibility on the PRGS site. In addition to the district energy analysis, the PRGS project will closely monitor regional electric grid emissions for progress with targeted reductions.

Blocks



Block development will finalize programming details necessary to establish the baseline from which operational carbon reductions will be assessed. Multidisciplinary coordination workshops with the consultant team will ideate opportunities for passive system efficiencies, load reductions, high performance systems, and energy recovery opportunities. Feasible solutions will be implemented while also balancing impacts to embodied carbon, human health, and resilience priorities.

See further information on strategies and systems for operational carbon reductions in the Energy & Carbon section [here](#) and District Energy Feasibility Study appendix [here](#).

Target 2 – 3% on-site Renewable Energy Generation

Site-wide



On-site solar photovoltaics (PV) are determined to be the optimal source for on-site renewable generation. The space availability for renewables will be balanced with site constraints and programming uses for stormwater management and amenity areas, while also identifying any synergies between these demands. Renewable energy technology has been incrementally improving over time and the PRGS project will continually review evolving technologies for increased productivity and cost efficiencies.

Blocks

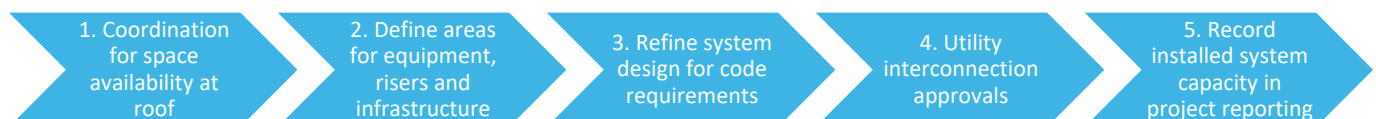

Rooftop solar PV is anticipated to be the strategy at block and building level for on-site generation. Final programming information will allow design teams to define feasible areas for horizontal rooftop systems and site structures where performance outputs have efficiency levels for financial feasibility, as well as the most responsible use of these finite resources.

Potential Roadblocks: On-site renewable energy is subject to interconnection approval from the local utility. With growing demand for clean energy, the utilities are having to balance distributed assets across an aging electric grid which may have the potential to cause barriers to implementation and/or delays in operation on-site.

See further information on on-site renewable energy strategies in the Energy & Carbon section [here](#).

Target 3 – 10% Embodied Carbon Reduction

Blocks



Embodied carbon reductions at the block development level will follow standard practice in the United States, largely influenced by the LEED green building rating system. Whole-building life-cycle assessment (LCA) baseline models will be analyzed with structure and enclosure components. This will establish prioritization for high impact materials to focus embodied carbon reduction strategies that will be reanalyzed to outline at least a 10% reduction trajectory. Feasible solutions will be implemented while also balancing impacts to operational carbon, human health, and resilience priorities.

Potential Roadblocks: Low carbon concrete solutions are currently dependent on the market availability of alternate materials, such as fly ash and slag, as adjacent industries are also in a period of change these materials are not guaranteed to be available long-term.

See further information on embodied carbon strategies in the Energy & Carbon section [here](#).

Target 4 – All-electric Buildings

Blocks



Planning for all-electric primary building systems (with exceptions for life safety, commercial kitchens, and common space) at the beginning of design allows the project to proactively plan for space requirements for equipment locations and conduit sizing at all phases of the project. Final programming information will allow design teams to optimize system sizing for coordination of the total incoming electrical load at each building, with limited exceptions. Along with system sizing, detailed design phases shall also review critical loads within the building and any dedicated circuits or subpanels that should be designed for future backup energy connection. Electrification of primary building systems ensures that there is a future pathway to carbon neutral operations while simultaneously delivering a high level of building performance and comfort.

Potential Roadblocks: Supply chains for critical equipment, such as transformers, for building electrification are currently severely backlogged due to production delays during the pandemic coupled with increased demand.

See further information on electric system strategies in the Energy & Carbon section [here](#).

Target 5 – Off-site Renewables



Carbon offsets and renewable energy certificates (RECs) will be analyzed closer to occupancy of buildings due to anticipated grid emission reductions and ongoing pricing volatility. Procurement criteria for off-site renewable investments are important to define in terms of who stands to benefit from this potential investment outside the City of Alexandria.

Potential Roadblocks: The availability of off-site renewable energy is a rapidly evolving market with weekly production capacity and pricing swings. Climate commitments are driving increased demand and more contracts are managed in bulk quantity.

See further information on off-site renewable energy strategies in the Energy & Carbon section [here](#).

Site Constraints

The PRGS property is 18.8 acres with significant constraints that reduce the buildable area of the site. Pepco holds a utility and transmission line easement along the southern and western portions of the site that services the existing substation, which will remain, as shown in blue in Figure 3. Permanent structures are not allowed within this easement area, which is limited to road and utility infrastructure or open space use. Additionally, the portions of the Potomac River Resource Protection Area (RPA) riparian buffer encroach on the eastern side of the site, as shown in pink in Figure 3. This area is intended to preserve and protect the water quality of the river. As such, development, land disturbance or vegetation removal (with the exception of invasive plants) is not permitted. Additional coordination, and ultimately approval, with the appropriate external stakeholders are required for any proposed sustainability strategies that would require permanent infrastructure or structures in these areas.

As mentioned above, there are existing utilities running within the primary road for the site within the Pepco easement. These include existing Pepco transmission lines and existing stormwater lines. Infrastructure coordination for both existing and proposed utilities occurs during early site planning for routing throughout the new site roadways including storm mains, sanitary mains, electric lines, and water lines.

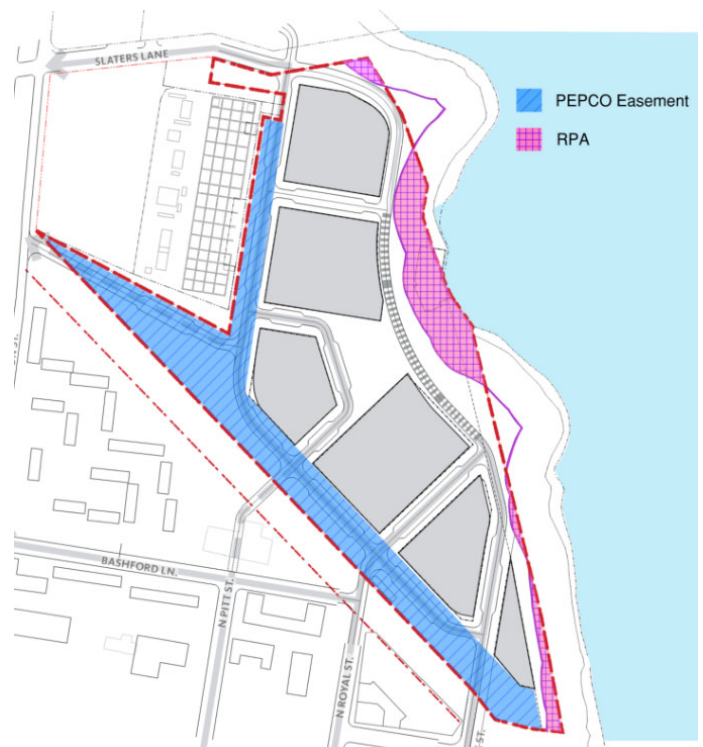

Figure 3: PRGS Site Constraints

Technical Feasibility

The building design and construction sector is not widely known as “early adopters” of emerging technologies due to the importance of ensuring long-term life safety for building occupants, which is also regulated through building codes. New strategies must be verified to meet robust screening criteria before a solution is deemed “market-ready.” This screening typically involves:

- Phased research and development – multiple revisions and upgrades to the original solution
- Real-life testing – significant number of prototypes and pilot projects are fully installed with proven performance data points
- Defined upkeep – operations and maintenance procedures and requirements are fully outlined
- Safety – meets applicable codes and standards

Once deemed “market-ready” a new solution would need to be analyzed for its performance impact specific to the PRGS development in terms of the project’s site, energy and carbon, water, human health, and resilience performance targets. When a strategy demonstrates significant positive performance impact, then it would move to the final step of assessing financial feasibility.

Financial Feasibility

Development projects require significant up-front financial investment over an extended period before a return on investment is realized. One of the key strategies to ensure long-term viability and financial success of a project is to assess payback periods of the anticipated return for any upfront investment. Lifecycle cost analysis of a sustainability strategy evaluates the long-term benefit of a system, looking at the initial cost of construction, savings from incentives and/or rebates, ongoing operations and maintenance costs, and anticipated utility savings. A payback period of 7 years is typically sought in commercial real estate investments. New and emerging technologies often have high first costs and longer payback periods given their unproven track records and slow market adoption. As we have seen in the market trajectory of solar PV panels since the 1980s, costs have dramatically reduced while performance has rapidly increased. More recently data has shown that commercial PV system costs have decreased by 69% while panel efficiency has increased by more than 2% between 2010 to 2020.² For this reason, systems that may not be financially viable in the first phase of development, can be earmarked for future review as both performance enhancements and price changes may be available for deployment in later phases.

1 - Identify strategy technical feasibility	2 - Define project performance impact	3 - Analyze financial feasibility
---	---------------------------------------	-----------------------------------

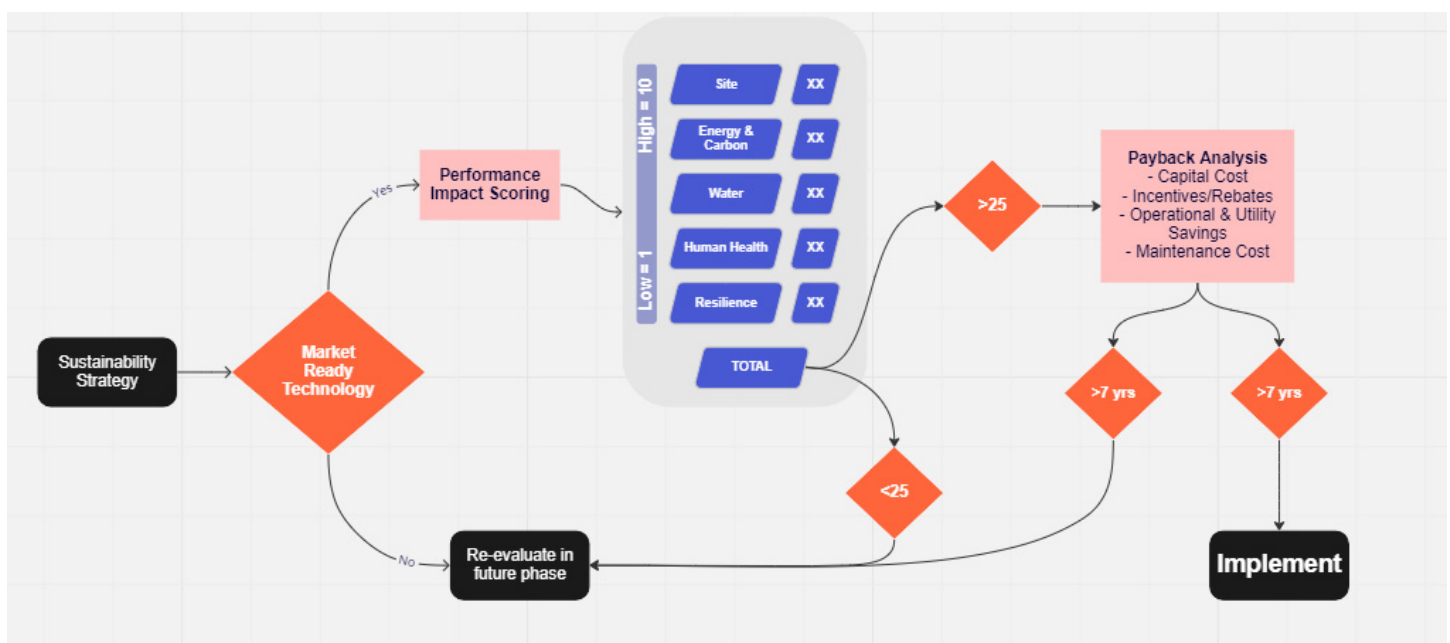

Figure 4: Flow Chart Graphic for Decision Making

² [NREL U.S. Solar Photovoltaic System and Energy Storage Cost Benchmark Q1 2020](#)

Recently passed incentives in the IRA, which was signed into law in August 2022, dedicates federal funding to clean energy, clean vehicles, clean buildings, and clean manufacturing aimed to drive down carbon emissions. Several of these federal funding mechanisms include prevailing wage requirements that can add to the overall cost of the sustainability solution, and overall construction costs so careful consideration is required to understand the impact to financial feasibility. Updates to the Investment Tax Credit (ITC) extends a 30% tax incentive for renewable energy systems through 2032 and adds newly defined bonus rebates. The additional 10% bonus rebates for qualified energy community locations and domestic manufacturing of renewable energy system components may benefit the PRGS project. The IRA also has created clean buildings tax incentives for multifamily residential properties for meeting Energy Star design requirements, and commercial buildings for energy performance improvements better than reference energy code standards. Both opportunities will be further evaluated at block design for the applicable building typologies for financial feasibility.



3. Sustainability Strategies

The sustainability strategies in this section outline ambitious objectives and targets. In analyzing them, the PRGS project will apply the following values and approaches:

Innovative

Teams will research and investigate beyond current market boundaries

Inclusive

Sustainability requires individual contributors to think about wider community benefits

Transparent

Working in partnership with the City to share lessons learned and outcomes

Integrated

Decisions will not be made in isolation and will be reviewed with a broad lens

In addition to these values and approaches, the LEED for Neighborhood Development (LEED ND) and LEED for Building Design + Construction (LEED BD+C) certifications will provide further affirmation of sustainable outcomes with third-party validation covering a holistic sustainability system.



Site

Strategies within the Site category aim to support a healthy, thriving community for all living species with a focus on development at a human scale.

A sustainable site is one that:

- Transforms depleted or contaminated sites into thriving residential and commercial uses connected into the community.
- Uses the natural environment to the benefit of the buildings and their occupants.
- Increases the local and regional open space connectivity.
- Balances multimodal demands with options that prioritize cyclists, pedestrians, and public transportation.
- Utilizes native and adapted flora and fauna to provide ecosystem habitats as well as programmatic function for users.
- Views precipitation as a resource rather than a waste product.
- Protects waterbodies and ecological communities.

Alignment with GBP:

No requirement – LEED Sustainable Sites credits will be pursued

Alignment with OTNSAP:

LEED ND Credits

Alignment with EAP 2040 Goals:

Increased Tree Canopy
 Increased Open Space per Resident
 Reduced Vehicle Miles Traveled
 Increased Transit, Walking & Biking

Site Targets		
Open Space and Biodiversity	Site-wide	5 acres on-site open space
	Site-wide	20% genus diversity in tree planting*
	Block	Quantify on-site sequestered carbon from plantings*
Green Infrastructure	Block	25% of green roof area is intensive with at least 6 species*
	Site-wide	2 acres green roof & bioretention systems*
Circulation & Transportation	Site-wide	4 DASH bus stops with shelters
	Site-wide	2 Bikeshare stations
	Block	2% off-street parking spaces with EV charging*

* voluntary commitment

Strategies in this section are cross-cutting to define interconnected systems between buildings, plants, animals, people, and all types of movement to and throughout the site. Many technologies and solutions in this space have been evolving for decades, with many feasible market-ready opportunities. Advances in research related to natural systems and vehicle technology are influencing innovative projects often seen in pilot phases, and emerging technologies still in beta phase.

Market-Ready	Innovative	Emerging
Diverse species planting	Ecosystem and habitat support	Biodiversity tracking and mapping
Green roofs and bioretention	Blue and purple roofs	Smart Streetlights
Bike shares and e-bikes	Autonomous vehicles	Drone delivery vehicles
EV chargers	On-route e-bus charging	

Open Space and Biodiversity

The project includes open space integrated throughout the site for both public and private use. Over 5 acres of publicly accessible open space proved in the project design, exceeding the on-site open space requirement in the OTNSAP. These new on-site open spaces will connect into approximately 8 acres of existing or new off-site open space that will be improved by the project, including waterfront open space along the Potomac River on National Park Service land, and a potential rails-to-trails conversion on the adjacent property owned by Norfolk Southern (NS) in coordination with the City. In total, approximately 14 acres of open space will be created or improved.

The Waterfront open space includes ecological education, and a native meadow. There are no tidal wetlands, floodplains, highly erodible soils, or streams on the project site. Nearly 1/3 of the site area is open space, the majority of which is vegetated space. The existing Resource Protection Area adjacent to the Potomac River will provide a buffer by naturally filtering pollutants from stormwater runoff, reducing the volume of stormwater runoff, preventing erosion, and supporting ecosystem functions.

Open spaces with diverse uses encourage active, healthy lifestyles. Research studies have also shown short- and long-term mental health benefits including lower anxiety and depression levels, reduced stress, and increased productivity across diverse age ranges from time spent outdoors. Green space is related to health benefits including lower premature mortality, longer life expectancy, improved mental health, less cardiovascular disease, and better cognitive functioning. Open space encourages movement, physical activity, and exercise. Walkable communities with pedestrian-friendly amenities and design can encourage two times more walking compared to communities that are less walkable.

Biodiversity is the variety of life on Earth, in all forms. The current ever-growing loss of biodiversity, which has been compounded by climate change, is a major crisis for communities and our planet. Global loss of biodiversity affects food, water, and energy security, as well as human well-being. Environmental regeneration shall be considered in this redevelopment project to ensure healthy functioning local ecosystems. Native and adapted landscaping promotes local biodiversity and reduces irrigation demands.

75% of private roof space excluding mechanical and amenity space will be either vegetated roofing or solar as required by CDD Condition 131

Diversity of tree planting in urban locations should follow the 10-20-30 rule: no more than 10% of any one species, 20% of any one genus, or 30% of any family to reduce the risk of catastrophic loss from pervasive pests. At the scale of the PRGS development a focus on the 20% genus target is recommended for the long-term viability of tree habitat which also contributes to reduced heat island effect, discussed in the resilience section. The private green roofs on buildings will also aim to contribute to site-wide biodiversity, including pollinator plants. Invasive species that are not indigenous to the area threaten biodiversity by competing with native organisms for limited resources and altering habitats that ultimately disrupt local ecosystems. The existing project site has invasive species including forbs, grasses, vines, shrubs, and trees that will be removed.

Key Strategies

- Remove all invasive species from both the PRGS and National Park Service (NPS) property to promote thriving ecosystems
- Design for open spaces to have passive and active uses with accessibility for all ages and abilities
- Utilize open space to support public programs to create a unified sense of place
- Increase connectivity to the waterfront at a pedestrian scale
- Create green corridor connections horizontally and vertically between planted areas

- Implement dark sky compliant streetlight fixtures with reduced glare and warm color temperature
- Maintain a site landscape inventory during operations

Green Infrastructure

Management of stormwater runoff to reduce water pollution in urban areas has traditionally been managed with gutters, pipes, and tunnels - known as gray infrastructure. As this gray infrastructure is aging and lessons are learned about efficiencies of managing more water on-site, developments of green infrastructure are more frequently used to filter and absorb water where it falls with nature-based solutions. This can include vegetated roofs, bioretention areas, rain gardens, and constructed wetlands. This localized perspective reduces energy demand to move water to treatment facilities and reduces the size and quantity of infrastructure materials.

Water management is of particular concern in Alexandria where the waterfront neighborhoods are seeing flooding due to more extreme weather events. The project will intentionally capture rainfall for reuse on-site first or filter and release it to the Potomac River to not add any additional stormwater flow to municipal treatment facilities. The project will also coordinate with the adjacent Pepco substation property for the capture, filtration, and release of rainfall from that site.

The amount of impervious surfaces, such as hardscape paving materials and compacted soil, affect hydrological cycles. The implementation of natural elements within green infrastructure solutions can mimic natural cycles, and better manage stormwater on-site.

Green infrastructure is also often referred to as Best Management Practices (BMPs) for stormwater management engineering. Bioretention areas, tree pits, and intensive and extensive vegetated roofs are contemplated in the Stormwater Management Master Plan submitted for City review. The development will also seek to implement green infrastructure and Low Impact Development (LID) practices to reduce stormwater runoff volumes to mimic a natural site hydrology not experienced across this site in nearly a century.

PRGS project will be designed to meet a minimum 20% reduction in stormwater phosphorus pollution and include strategies to exceed this percentage as required by VDEQ and CDD Conditions 124 - 128

Green infrastructure strategies for the project include bioretention areas, green roofs, and a rainwater detention vault. The bioretention areas area located along project roadways and proposed on podium roofs for blocks B, C, D, E and F will be defined in individual block DSUPs. Each block will have green roofs for stormwater retention and will be finalized as part of individual block DSUPs. These measures reduce the overall stormwater runoff from the site utilizing nature-based solutions.

Key Strategies

- Create or improve approximately 14 acres of publicly accessible open space with a majority of pervious surfaces
- Design green infrastructure bioretention systems with appropriate setbacks for pedestrians, bicyclists, and retail use
- Integrate deep rooted native grasses into planting designs to support soil biological activity
- Monitor, inspect and maintain green infrastructure systems bi-annually during operations

Circulation & Transportation

Multimodal Transportation

The urban context and mixed-use design of the PRGS redevelopment supports public transit, cycling and walking to intentionally drive down the use of single occupant vehicles. As part of the Old Town North neighborhood, the site is in proximity to Old Town and NorthEast Alexandria neighborhoods creating a highly walkable destination. The Mount Vernon Trail adjacent to the Potomac River draws pedestrians and cyclists for both recreational and commuter trips through this space, and directly connects to the North Potomac Yard redevelopment site. Convenient and accessible pedestrian and cyclist connections between on-site amenities and facilities encourages residents and visitors to live an active, healthy, and low carbon lifestyle.

In addition to the PRGS Multimodal Transportation Plan from February 2022, the project will be completing a Transportation Management Plan submission aligned with the City of Alexandria’s current regulations and aligned with CDD Condition 69. The project further aims to encourage human powered transportation options with safe sidewalks and connections to the Mount Vernon Trail, Capital Bikeshare stations on the site, and on-street bike lanes. N. Royal Street will be extended into the site as a “Green Street” in accordance with the OTNSAP. There are enhanced painted bike lanes crossing Road A at Slater’s Lane and Road B. Pedestrian and bicycle connections will be provided to the Mt. Vernon Trail in three locations. Public transportation access is planned along Street A with two bus stops with shelters in each direction and a proposed shuttle that would provide access to the Braddock Rd and Potomac Yard Metro stations.

A “woonerf” is a living street, touted as the Dutch way of city planning. Woonerven reimagine thoroughfares as more than a vehicular-focused pathway to get from place to place. Rather, woonerf-designed streets reimagine streets as social spaces in addition to

accommodating multi-modal transportation. The street is shared between cyclists, pedestrians, and vehicles, while pedestrians have priority over cars. In this project, the woonerf is an extension of North Fairfax St. It will act as shared space that uses non-traditional design to elevate pedestrian priority, slow vehicular speeds, and ultimately create a seamless and flexible space that allows users to develop a sense of place and minimize the roadway as a barrier to the waterfront. The majority of the open space within the development is between the blocks and the Potomac River, and the woonerf will work to elevate that space to optimize user experience.

Zero-emission vehicles

A zero-emission vehicle (ZEV) is defined here as a vehicle that does not emit exhaust or pollutants from the tailpipe during operation. ZEVs are important tools to achieve City GHG reduction goals as approximately 1/3 of overall emissions come from transportation. Passenger vehicles are currently the largest proportion of ZEVs available, but there is also growth in the electric-bicycle market. The PRGS facilities have an opportunity to support electrified vehicles with charging infrastructure. This may be Level 1 smart plugs with QR codes for charging and access, Level 2 chargers with 240V electrical connection or DC fast chargers. The project has created a framework to allow the key strategies below to be implemented at the project site.

Key Strategies

- Create a woonerf along North Fairfax Street as a vehicle reduction measure
- Provide underground parking
- Coordinate with NPS, NS, & City of Alexandria to connect to existing pedestrian & cycling infrastructure
- North Royal Green Street Extension
- Design inclusive bicycle parking, storage, and access to changing/showers for each block based on programming
- Coordinate DASH bus route connections to metro stations with City staff/DASH
- Coordinate Capital Bikeshare station locations
- Implement protected, marked, and lighted pedestrian and cyclist connections
- Designate centralized pick-up and drop-off zones for rideshare users
- Identify electrical panel connections for EV ready infrastructure connections
- Evaluate ZEV carshare opportunities

Energy & Carbon

Building design and operations play a central role in the City of Alexandria’s efforts to mitigate the impacts of climate change. As of 2018, new and existing buildings in Alexandria contribute to 59% of the City’s GHG emissions (ECCAP), providing an opportunity to reduce carbon emissions through improvements to building design and construction, as well as subsequent building operations.

The principal design approach pertaining to energy and carbon follows the maxim “*reduce, optimize, produce/procure.*” The project shall define opportunities to reduce energy consumption and carbon emissions (operational and embodied). It will also seek to optimize performance to ensure that the energy and carbon utilized has been put to the best use. Additionally, the project will target both on-site renewable energy production and investigate opportunities for off-site renewable energy procurement.

Alignment with GBP:

LEED Optimize Energy Performance credit

Alignment with EAP 2040 Goals:

Renewable offset electrical use
Improved energy efficiency
Reduce GHG emissions per capita

Energy & Carbon Targets		
Operational Carbon	Block	100% electric HVAC & DHW systems
	Block	2021 IECC EUI
Renewables	Site-wide	3% on-site renewable energy generation
Embodied Carbon	Block	10% building embodied carbon reduction
	Site-wide	Measure additional horizontal concrete embodied carbon reduction*

* voluntary commitment

The subsequent sections discuss strategies for energy and carbon performance, feasibility of on-site renewables, best practices of off-site renewables and embodied carbon performance.

Terminology

ASHRAE: American Society of Heating, Refrigerating, and Air-Conditioning Engineers

CLF: Carbon Leadership Forum; research and education at the University of Washington developing information, datasets, and targets for embodied carbon

DHW: domestic hot water

ECI: embodied carbon intensity; measure of GHG emissions resulting from the manufacture, transport, installation, maintenance, and disposal of building materials per building floor area; metric: kg CO₂e/ft²

ECM: energy conservation measure; a strategy or implementation designed to reduce building energy use

EUI: energy use intensity; a measure of annual building energy use per building floor area; metric: kBtu/ft²/yr

IECC: International Energy Conservation Code; code addressing building energy efficiency requirements

GHG: greenhouse gas emissions; gases released into the atmosphere that contribute to the greenhouse effect (trapping solar energy within the Earth's atmosphere and thus contributing to warming); principal gases are water vapor, carbon dioxide, methane, nitrous oxide, hydrofluorocarbons, perfluorocarbons, and sulfur hexafluoride

GWP: global warming potential; describes the warming effect that different GHGs have on the Earth's warming; i.e.: the release of one kilo of methane into the atmosphere has a GWP twenty-five (25) times greater than the release of one kilo of carbon dioxide; GWP facilitates comparison between the impact of the release of different GHGs

HVAC: heating, ventilation, and air conditioning

IPCC: Intergovernmental Panel on Climate Change

PPA: power purchase agreement; a contractual agreement between energy buyers and sellers in which both parties agree to an amount of energy to be bought/sold from a renewable asset

PV: photovoltaics

REC: renewable energy credit; market-based instrument representing the property rights to the environmental and social benefits for one megawatt hour of electricity generated from a renewable asset

RPS: renewable portfolio standard; a set of policies set forth to increase the nameplate capacity of renewables within state lines.

SERC: solar renewable energy certificate

Solar Carve-out: a policy that requires a certain percent of renewables installed, due to an RPS, to be solar

Solar Irradiance: the power of solar radiation per unit of area, expressed as W/m²

Strategies in this section are targeting better building performance and materials to reduce carbon emissions. . Investment and research funding into these areas have been rapidly increasing, which is expected to continue in the near term. Innovative solutions are being rapidly deployed which informs the pricing and performance metrics available in the market.

Market-Ready	Innovative	Emerging
VRF system with energy recovery	Geothermal heat pumps	Large scale heat pumps
Rooftop PV arrays	Vertical building integrated PV	Kinetic pavers
Mineral wool insulation	Mass timber structure	Low carbon aggregate polymers
Steel with high recycled content	Low carbon concrete	

Energy Context

Energy Codes

Energy codes serve two purposes in the design and development of the PRGS site: building permitting and green building certifications. Building codes required for permits and municipal approvals in the United States are adopted at the State level, following either ASHRAE 90.1 or International Energy Conservation Code (IECC). Both codes outline energy efficiency requirements for envelope, power and lighting systems, mechanical systems, service water heating; commissioning requirements; and building performance verification standards.

Green building certification programs mostly reference ASHRAE 90.1 standards with differing years depending on the version of the rating system. These are utilized for demonstrating building performance metrics following either prescriptive requirements or a performance pathway using energy modeling software. Energy modeling simulation provides quantifiable results as a predictor of energy use intensity metric (EUI) during design phases. The Alexandria Green Building Policy (GBP) has compliance pathways through either LEED or Green Globes. The PRGS site and blocks anticipate using LEED v4 as the GBP pathway for the first phase of certifications.

Energy Code Baseline References:

VA Energy Code:
IECC 2018 / ASHRAE 90.1-2016

LEED v4.1:
ASHRAE 90.1-2016

LEED v4:
ASHRAE 90.1-2010

Green Globes:
ASHRAE 90.1-2010

Energy Targets

Per CDD Condition 139a Target 1, the project must either achieve a 25% reduction in operational carbon in alignment with ASHRAE 90.1-2010 or an EUI in alignment with IECC 2021. The establishment of the operational carbon baseline is set via Appendix G of ASHRAE 90.1-2010, while the EUI target is set via Table CC103.1 of the IECC 2021 for climate zone 4A. Climate zones correspond to weather patterns, temperature, humidity, and seasonal changes. These factors impact HVAC design, as there are differing numbers of heating degree days and cooling degree days dependent on location. Climate zone 4A is a mixed-humid climate.

With a future focused perspective, the project is establishing site-wide EUI performance targets based on IECC 2021 program types with the most current program available at this time. The project, which includes up to 2.5 million ft² of development is broken out into two principal uses: residential and commercial. The final program break-out will evolve in each phase as the design progresses, and the programmatic blend will be essential in informing the design EUI target for each block. Presently, the design assumption is that 80% of the floor area will be residential use (R-2 type multi-family), while 20% will be commercial use. The City of Alexandria includes the following programming types under commercial use as applicable to this project – office (B type), hotel (R-1 type), restaurant (A-2 type) and retail (M type).

According to Table CC103.1 of the IECC 2021, the EUI targets for climate zone 4A for each standalone building typology are as follows:

- Multi-family (R-2) EUI: 45 kBtu/ft²/yr
- Restaurant (A-2) EUI: 483 kBtu/ft²/yr
- Hotel (R-1) EUI : 69 kBtu/ft²/yr
- Office (B) EUI: 28 kBtu/ft²/yr
- Retail (M) EUI: 48 kBtu/ft²/yr

In order to establish a project-specific EUI baseline, these benchmarks are area-weighted relative to the assumed 80% residential, 20% commercial program blend, which yields a **project maximum site EUI of 50.6 kBtu/ft²/yr** following the IECC 2021 pathway. Should the program blend change, the target EUI would be revised to reflect the actual program. As evidenced by the IECC climate zone specific targets, there is variation in EUI between different uses, but even within these program typologies there can be energy use variation related to project specific design (i.e. building scale, system efficiency, construction typology) that are best interrogated via detailed energy modeling at each block as actual building-level information is developed.

District Energy Feasibility

In the pursuit of energy use reduction, district energy systems utilizing cogeneration plants have been heralded in recent years as high-performance solutions for multi-building projects. These systems simultaneously generate electricity and heat from one primary energy source - typically natural gas. These solutions lock in the use of fossil fuels and on-site carbon emissions for the 25+ year life of the system. As a result, cogeneration plants are now falling out of favor as the benefits of the operational energy efficiency from the natural gas systems are outweighed by the long-term carbon emissions and the negative impacts on human health.

The PRGS team performed a comprehensive district energy feasibility study that assessed *only non-combustion* (all-electric) options for thermal energy exchange between buildings. The options studied included: building energy recovery, geothermal heat exchange, sewer heat exchange, anaerobic digestion and river water energy exchange utilizing a shared thermal energy loop for heating and cooling

demand. The project team has worked to research different system options, weighing energy efficiency, operations, operational and embodied carbon, and financial feasibility. In any district energy analysis, it is important to consider the embodied carbon generated by the additional infrastructure required for a district-wide system. Additional infrastructure includes a site-wide conduit loop encased in concrete, and optional elements such as deep geothermal wells and heat exchangers.

The district energy systems assessed demonstrate very minimal energy savings compared to implementing high efficiency, all-electric, stand-alone building-level HVAC and DHW systems with enhanced envelope design. The minimal operational performance improvements coupled with an increase in embodied carbon and an extremely long payback period make district energy solutions infeasible at this site. Constraints specific to this location include minimal open areas for geothermal solutions; geothermal wells beneath the parking garage would have limited or no access for maintenance; and phased block development with varying below grade parking structure depths. Other limitations on district energy systems include shallow river depths resulting in lack of heat transfer capacity, and high residential programming which does not provide enough diversity for energy recovery. District energy systems are most feasible when there is a greater diversity of use with residential being closer to only 50% of the program to benefit from a higher instance of simultaneous heating and cooling loads – such as a university campus. Further details about the district energy systems evaluated, constraints, assumptions and results are available in Appendix .

Efficiency and Operational Carbon

Operational carbon refers to the GHG emissions released to run and utilize a building (the carbon emissions resulting from operations). These emissions occur as long as a building is operating, and thus can have a major environmental impact as annual operational emissions accrue over a project's lifetime. When operational carbon is combined with embodied carbon (GHG emissions associated with the manufacture, transport, installation, maintenance, and disposal of building materials), this is referred to as whole life-cycle carbon.

Operational carbon is calculated by converting building energy consumption by fuel source to carbon emissions. The metric for operational carbon is kilograms of carbon dioxide equivalent (kg CO₂e), which expresses the GWP of project emissions. At the building scale, operational carbon can either be reported as a whole building total (in tons of CO₂e), or on a per square foot intensity basis (in kg CO₂e/ft²).

While energy intensity and carbon intensity are related, they are not directly proportional. Energy use and energy use intensity are principally driven by building program and occupant behaviors. Certain building programs are inherently more energy intensive, such as healthcare or restaurant uses. These typologies have high process loads driven by the equipment necessary for operation (i.e.: MRI machines or cooktops and ovens). Building program also affects operational schedules; buildings that are utilized more frequently will have greater energy demands (i.e.: a building that operates 24/7). Finally, occupant behavior affects energy use as well. As initially described in the [Carbon Neutrality Analysis](#) (CNA), the owner and operator of a building has the power to influence energy intensive systems in the building; however, there are many end uses that are solely under resident/tenant control. These include residential lighting, plug load, hot water, and appliances. Even within the same building typology, occupants can have different behaviors (i.e.: leaving lights or equipment on when not in use or adjusting heating setpoints). While design efforts can work to account for some of these via robust assumptions and certain technical implementations, **occupant behavior will always be outside of direct control and can lead to variations between predicted and actual energy use.** For this reason, energy efficiency design strategies are primarily focused on the building components that are in direct control of the owner and operator – which is less than 50% of the overall energy demand for multi-family and office typologies.

Urban developments also benefit from a lower operational carbon impact per capita. As compared to single family and low-rise residential, the individual multifamily units at the PRGS project will have a smaller carbon footprint. Mid-rise multifamily building EUI targets are higher than smaller scale residential targets due to the same energy intensive programs (i.e. kitchen appliances) in a smaller overall area, with the addition of process loads, like elevators and plug loads, but provide an opportunity for Alexandria residents to live a lower carbon lifestyle from the efficiency gained through density.

While buildings need to use energy to operate, a direct increase in energy use does always correspond to a direct increase in operational carbon emissions. Energy derived from fossil fuels results in the release of GHG emissions, whether those fossils are used for on-site combustion or to produce electricity for the grid. However, if building operations are electrified, there is the opportunity to ensure that electricity used to operate a building comes from clean, renewable sources. This framework illuminates the importance of working towards cleaner power generation for the grid. Therefore, decoupling of energy and carbon intensity for building operations is achieved via building electrification and application of the “reduce, optimize, produce/procure” framework detailed in the following table.

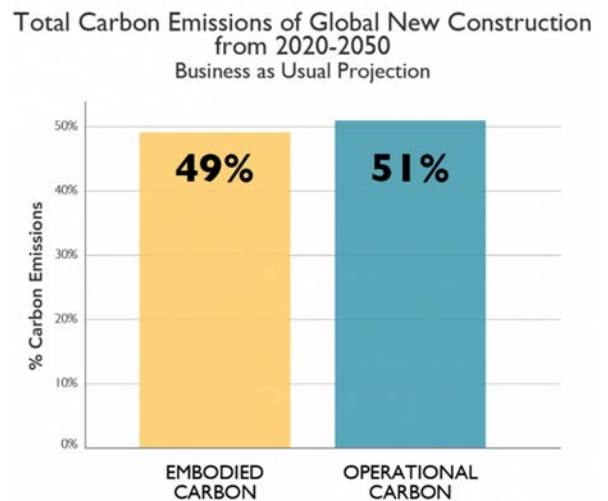

Figure 5: Comparison of embodied vs operational carbon impacts (source: Architecture 2030)

Reduce, Optimize, Produce/Procure Framework

Core Framework Component	Strategic Approach	Summary
Reduce	<i>Reduce principal project energy demand.</i>	The simplest way to reduce operational carbon is by reducing energy consumption. Seek ways to eliminate unnecessary energy consumption via design and operation measures.
Optimize	<i>Increase the efficiency of systems; optimize the energy used to eliminate energy waste.</i>	Buildings use energy, but it is essential to ensure that any energy consumed is consumed efficiently and intelligently. By optimizing performance with more efficient systems or capturing energy that would otherwise be wasted, buildings can ensure that energy consumed is used to its fullest potential.
Produce / Procure	<i>After reducing energy demand and optimizing performance, produce energy on-site via renewables or purchase via off-site renewables</i>	After reducing demand and improving efficiency, the final step in evaluating building energy comes from renewable sources. These renewables can be produced on-site, or purchased from off-site renewable sources, providing a pathway to net zero carbon operations. Additionally, having followed the prior two steps within this framework, the amount of energy that needs to be produced or procured via renewable sources will be less than in a project that did not follow a similar approach.

The combination of the “reduce, optimize, produce/procure” framework with the electrification of primary building operations fundamentally sets up PRGS buildings to be operational carbon neutral ready in alignment with the EAP 2040 carbon neutral operations goal. This is a result of the possibility of electricity being produced entirely from renewable sources from the electrical grid over time, thus reducing the GHG emissions associated with energy generation to zero.

Key Strategies

- Implement occupancy sensors, time schedules and/or daylight sensors to minimize lighting demand
- Evaluate enhanced envelope strategies to reduce thermal transmittance (U-value) and improve air tightness to reduce heating and cooling loads
- Install LED lighting and ENERGY STAR rated appliances
- Perform whole building energy modeling to evaluate detailed design options
- Study external shading on building facades to reduce summer cooling loads
- Design electrified systems for carbon neutral-ready buildings
- Perform commissioning for envelope and building systems to ensure proper operations from day one

Renewables

Renewable energy uses naturally replenishing resources such as wind, sunlight, and water to produce energy without emitting emissions into the atmosphere. Renewables are a clean alternative to traditional power generating energy where burning fossil fuels have been linked to being the dominant cause of climate change. In an attempt to mitigate the severity of climate change and spur increased adoption of clean energy, many states have adopted renewable portfolio standards (RPS). This is a regulatory mandate which increases the energy produced by renewables. In 2020, Virginia passed the Virginia Clean Economy Act, which established an RPS requiring its two largest utility providers, Dominion Energy and Appalachian Power Company, to phase out all fossil fuels by 2045 and 2050 respectively. This legislation has opened the door to future incentive programs within Virginia and is expected to drive down carbon emissions from the electric grid over time. **This electric grid policy requirement coupled with the PRGS project’s commitment that primary building systems be all-electric means that over time, the development may achieve carbon neutrality.**

In urban locations, rooftop solar PV systems are traditionally the most feasible renewable energy generation source for electricity. Wind energy systems would not be feasible on this site due to the adjacent Washington Reagan National airport, the related FAA restrictions, wildlife and bird habitats in the adjacent National Park Service land and low average annual wind speeds in the area. Similarly, the PRGS site does not have enough linear riverbank access or depth at the adjacent Potomac River areas for tidal power systems. Smaller scale energy generation from kinetic footfall pavers, regenerative gym equipment and other innovative energy solutions are typically used in educational and art installations as the quantity needed to meaningfully contribute to the energy generation at this scale of development would not be feasible.

Kinetic pavers would require the site to capture **400 million footfall steps** on kinetic pavers to generate **1 MWh of off-grid energy**

On-site Renewables

On-site Renewables

CDD Condition 139b Target 2 establishes a target that 3% of project's annual energy demand be produced via on-site renewables. The condition does not prescribe the renewable energy technology to be used. A feasibility study to assess the potential for solar and small-scaled wind infrastructure on the site was conducted by the design team. As solar PV is the most feasible technology, a pathway to meeting the 3% on-site generation target was outlined using locations on building penthouse roofs, south- and south-west facing penthouse facades, canopies over roof amenities, and site structures. These allocations outline physical space demands and panel production for each block, which will be further refined by each block's design team as the project develops.

PV production largely depends on panel and system efficiency, orientation, and shading. Panel efficiency is driven by the semiconducting material used to convert sunlight into electricity. Commercial panel efficiency typically falls between 18-20%, yet recently has been tested as high as 25%. PV system efficiency is correlated with the distance between generation at the panel and conversion into usable grid electricity at the utility meter. Orientation of the panel will determine how much of the sun's solar irradiance can be captured by the panel and turned into useful energy. The optimal PV panel tilt degree changes throughout the seasons but can generally be aligned with a location's latitude - 38 degrees for Alexandria - and facing due South in the Northern Hemisphere. However, rooftop PV systems typically are horizontally mounted with a 10 degree or less tilt to best manage structural wind loads. Vertical façade-mounted PV panels have significantly lower production due to the reduced exposure to sun hours throughout each day from their 90-degree orientation. Performance of vertical mounted PV panels will be more closely evaluated by each block design team to ensure that production outputs are high enough to ensure technical feasibility to justify using the critical mineral commodities³ utilized in manufacturing the panels, as well as financial feasibility with higher first costs for mounting solutions and lower utility savings from production.



Figure 6. Preliminary On-Site Renewable Energy

For the PGRS PV Study, a 360-watt rooftop panel with 20.6% efficiency mounted at a 10-degree tilt was evaluated. Other considerations included space allocations for green roofs systems for stormwater management, mechanical, electrical, and plumbing equipment space, and shading. As the current maximum EUI is 50.6 kBtu/ft²/yr, at 2.5 million ft², the approximate annual energy consumption for the site would be no more than ~30,000 MWh, of which 3% would result in a target of **900 MWh** of annual electricity produced from on-site renewables. However, this is based on a hypothetical maximum project energy performance. Should the project be able to achieve a lower EUI as block designs develop, this absolute renewable energy generation target would decrease in kind.

Off-site Renewables

Off-site renewable energy provides an opportunity for electrified buildings to procure clean energy while the regional grid still has some combustion-based generation from coal and natural gas. Clean energy procurement includes renewable energy credits (RECs) and power purchase agreements (PPAs) which may be sought to offset electricity emissions.

RECs are tradable commodities quantified by 1 MWh (1,000 kWh) of electricity generated by renewable energy sources (solar, wind, hydroelectric, etc.). RECs are not purchased with the intention of covering electricity needs, but rather to acquire the environmental benefits associated with generating zero carbon electricity. The cost of RECs is highly volatile as the industry grows and demand for RECs



Figure 7. National REC Pricing

³ [Critical Mineral Commodities in Renewable Energy - USGS](#)

increases over time. In the United States, the cost of RECs hit a record high in August 2021 as shown in Figure 7. While prices dropped after the peak, current pricing at the end of 2022 and early 2023 is currently on the rise again. It is anticipated that market demand will drive continued cost increases as more entities commit to sustainable practices and carbon reduction targets.

Clean energy procurement from RECs and PPAs have different qualifying factors and verification processes available. Since these may also contribute to the building LEED certifications, the project will reference the USGBC classification categories of renewable energy procurement:

- Tier 1: On-site generation
- Tier 2: New off-site renewable energy – PPAs or virtual PPAs
 - Produced by generation assets built within the past 5 years or contracted to be operational within 2 years of application
 - Minimum 10-year contract term
- Tier 3: Off-site renewable energy – utility green tariff programs or wholesale RECs
 - Green-e Energy certified

As outlined in the on-site renewables section above, Tier 1 classification entails a return on investment for the implementation of systems that generate utility savings. Conversely, Tier 2 and 3 renewables do not provide a return on investment. PPAs and RECs are typically procured as buildings or portfolio projects are nearing occupancy, and therefore operations. Therefore, the price of those future opportunities is unknown at this time. Evaluation of future PPA and REC procurement options for PRGS will focus on projects that would be contributing to the regional electric grid to drive localized carbon emissions reductions throughout the area. Further cost information can be found in the appendix.

Similar to RECs and PPAs, carbon offsets also are intended to replace emissions generated from the built environment, but they do so through procurement based on tons of CO₂ saved. There are two types of carbon offsets; ones that *remove* carbon from the air, like sequestration from trees, or ones that *avoid* using emission-emitting processes, like sourcing renewables. The cost of carbon offsets is driven by federal policies, supply and demand market dynamics, and organizational carbon reduction commitments.

The investment in these clean energy procurement options will not contribute to reducing GHG emissions in the City of Alexandria. Understanding whether to use RECs or carbon offsets to meet sustainability goals requires entities to vet the quality of each option. While some carbon offsets may have significantly lower costs than RECs, the verification of impact they have in avoiding emissions and who benefits from these avoided emissions are important considerations.

Key Strategies

- Determine rooftop horizontal PV areas and production, then evaluate performance of vertical mounted PV, and PV mounted on shade and canopy structures
- Evaluate availability of high-performance PV panels and feasibility
- Establish performance thresholds for all PV installations (kWh produced / kW installed) for responsible use of rare minerals
- Investigate updated federal Investment Tax Credit incentives for renewables
- Evaluate feasibility of off-site renewable energy opportunities and define procurement preferences

Embodied Carbon

In the building industry, embodied carbon refers to the GHG emissions resulting from the manufacture, transport, installation, maintenance, and disposal of building materials. Manufacturing of building materials is estimated to be responsible for 11% of global energy-related carbon dioxide emissions. When embodied carbon is combined with operational carbon (GHG emissions associated with building energy consumption), this is referred to as whole life-cycle carbon.

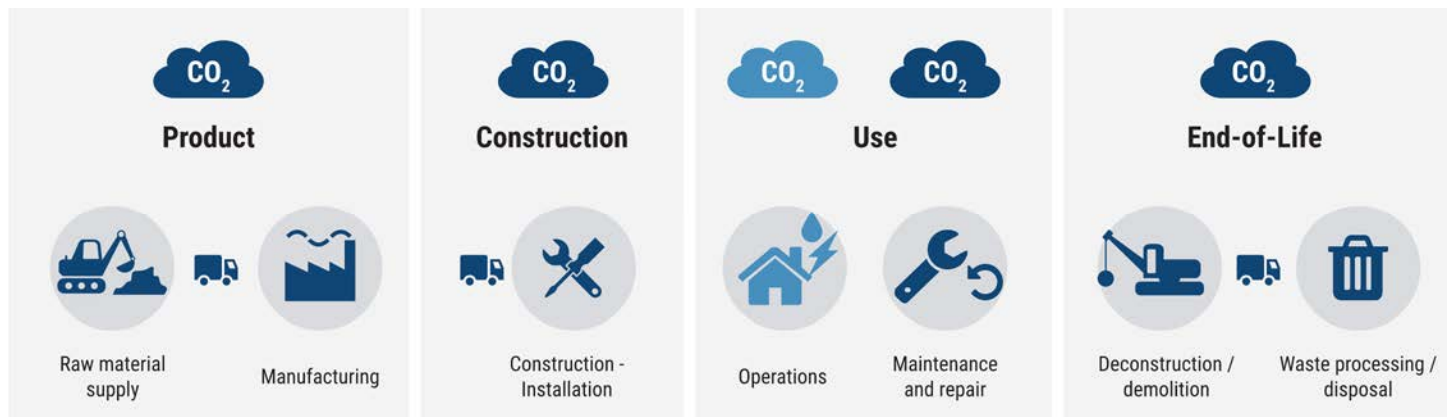

Figure 8. Whole life-carbon cycle

Embodied carbon is calculated through a method called life cycle assessment (LCA), which tracks the emissions produced over the full life cycle of a product. Embodied carbon is measured using the metric of global warming potential (GWP), which is quantified in kilograms of CO₂ equivalent emissions (kg CO₂e). At a building scale, embodied carbon is typically reported in terms of carbon intensity on a kg CO₂e/m² basis and reported under Scope 3 emissions in GHG Inventory reporting.

Energy codes and clean energy generation have made significant progress in reducing operational GHG emissions. Therefore, the proportion of fixed embodied carbon emissions has become more significant when evaluating whole life carbon. The “time value of carbon” is the concept that emissions reductions now are more valuable than emissions reduction later. Due to the time value of carbon, there is an urgent need to address embodied carbon now to meet short-term and long-term science-based climate targets.

Embodied carbon is quantified using a whole-building LCA baseline model made up of structure and enclosure components. This methodology establishes the building baseline from which embodied carbon is reduced. The baseline model allows teams to define the highest impact materials to prioritize reduction targets. High impact materials are traditionally the following:

- Concrete
- Steel
- Aluminum
- Insulation

More recent advances in standards for low carbon horizontal materials are also new to the industry. This consists of design recommendations for concrete and asphalt paving materials. Low carbon asphalt requires unique construction equipment and it is expected to take some time for contractors to procure this special equipment to be able to start deploying more pilot projects.

The greatest opportunities for embodied carbon reduction occur during the initial planning stages of a project. As a project progresses, the opportunities to influence embodied carbon reduction decrease and costs often increase. Basic principles for embodied carbon reduction at various phases of design are outlined in the table shown on the next page.

Basic Principles for Embodied Carbon Reduction		
	Design Stage	Summary
Build less	Planning	The simplest way to reduce embodied carbon is by building less. Prioritizing in-line and adaptive reuse projects significantly reduces the amount of new materials required, resulting in fewer emissions.
Build clever	Design	During design, embodied carbon can be reduced by building clever. Revising structural systems, optimizing material usage, and designing with low-impact and local materials can reduce the embodied carbon of new construction projects by 10-50% compared to a business-as-usual design. This is achieved by optimizing design standards and rewriting high-impact product specifications to mandate pre-determined GWP reduction targets.
Build efficient	Construction	The final opportunity to reduce embodied carbon content is by building efficiently, reducing the emissions associated with the construction process itself. This can be accomplished by modifying building elements for improved constructability or implementing a streamlined construction process such as modular design.

Key Strategies

- Revise concrete mix design to reduce embodied GWP (alternative cementitious materials, recycled aggregate, etc.)
- Select alternative cladding products with reduced GWP
- Limit use of spray-foam insulation
- Reduce use of and/or replace steel and aluminum products with low carbon alternatives
- Reduce cavity fill insulation by increasing thickness of continuous insulation layer
- Utilize modular building components to increase construction efficiency
- Incorporate materials with high recycled content
- Evaluation of additional embodied carbon from district energy systems
- Research local manufacturers and products with reduced transportation impacts
- Re-use existing pumphouse and guardhouse on the PRGS site

Water

Buildings are recognized as one of the highest users of freshwater resources. In the built environment, reducing indoor and outdoor water use and maximizing water reuse potential is crucial to mitigating excess water demand on local infrastructure systems. Minimizing water demand on-site reduces energy use at the utility by reducing required operational energy used for pumping water through treatment systems and to the project site.

The City of Alexandria earned LEED Gold for Cities & Communities V4.1 certification in May 2022. LEED for existing cities requires the prerequisite for Integrated Water Management that requires reduced freshwater consumption and encourages a shift to a net zero water city. Following in suit with this commitment to a sustainable future for the community, the project strives to use sustainable water strategies using a wholistic approach to the site-wide water demand balance.

The strategies outlined in this section support the project’s minimum targets of 50% reduction in outdoor water use and 40% reduction in indoor water use as outlined in the Green Building Policy priority Performance Points.

Alignment with GBP:

- LEED 50% Outdoor water use reduction credit
- LEED 40% Indoor water use reduction credit

Alignment with EAP 2040 Goals:

- Surpass stormwater phosphorus pollution reduction (MS4) target

Water Targets		
Potable Water Demand	Site-wide	50% outdoor water use reduction
	Block	40% indoor water use reduction
Storage & Reuse	Block	Quantify water reuse with meters*

* voluntary commitment

Strategies in this section aim to think broadly across the planet's water cycle and how the PRGS development can be a responsible steward of this resource. Many technologies and solutions in this space have been evolving for decades, with many feasible 'market-ready' opportunities.

Market-Ready	Innovative	Emerging
Low-flow fixtures & Water efficient appliances	Graywater and condensate reuse	Groundwater from basement dewatering
Drip irrigation	Smart Leak Monitoring	River water for direct non-potable reuse
Cistern storage for reuse	Intelligent Irrigation	Water meter smart tariffs

Efficiency & Potable Water Demand Reduction

Whole-site Water Demand Analysis

For a redevelopment site with multiple buildings, it is important to understand the overall water balance of the site. The incoming water demand supports overall indoor and outdoor water demand for building systems, landscape irrigation, and human consumption. Wastewater from the project leaves the buildings and site via storm and sanitary drainage. The site design incorporates stormwater management strategies to reduce stormwater runoff from the site. These strategies, as described in the Site portion of this CSS, include bioretention areas and green roofs. These measures reduce the overall stormwater runoff from the site.

Current estimates for overall site sanitary flow are 28,200 gallons/day at full build. This accounts for both greywater and blackwater for the site. Preliminary estimates for site stormwater include approximately 455,000 gallons of site retention potential. Mechanical system water demand may include cooling tower make-up water if buildings use water-cooled systems, and that water could be supplied from stormwater retained on-site. As the block design progresses, a water balance will be considered between non-potable demands and potential for re-use, which are outlined in the Storage and Reuse section below.



Figure 9. Site Water Strategies

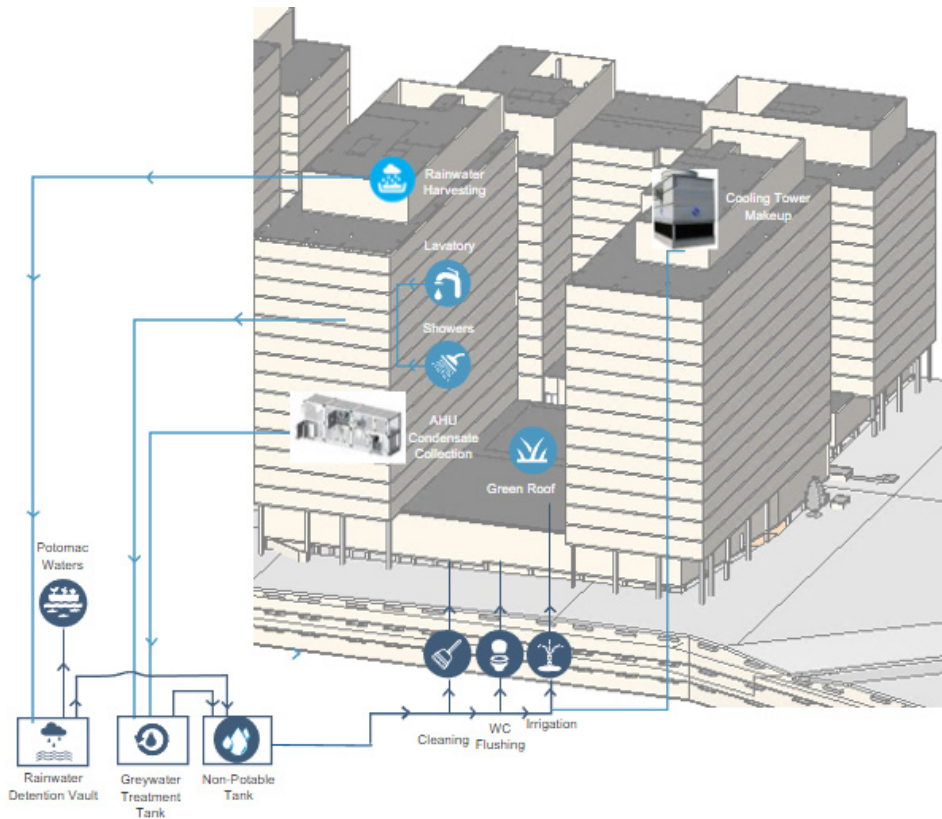

Figure 10. Block-level water reuse strategies

Indoor Water Use

Reducing potable water use refers to reducing the total water used for building systems and human consumption. As described in the overall site water demand analysis, multifamily and commercial buildings use water for a variety of end uses. Ultra-efficient fixtures and fittings are one of the most cost-effective ways of reducing and maintaining reduction of potable water use within buildings. These include aerator and flow restricted faucets, showerheads, urinals, and water closets. Water efficient appliances include low water consumption washing machines and dishwashers in residential applications, and low water consumption commercial kitchen equipment and dishwashers in retail spaces. Using water efficient appliances within the project will not only reduce the water consumption, but also the energy consumption of heating and pumping water.

Leakage management is one of the most resource and cost-effective measures in reducing water consumption within buildings. Simple analytics on monthly metered data can help identify units with leaking fixtures. High resolution meter or innovations in smart meters can further aid identification of leaking fixtures and prevent losses.

Outdoor Water Use

Reducing outdoor water use refers to reducing the total water used to maintain and operate landscaped areas. Design for open space will include pervious materials and plant vegetation that requires minimal irrigation. Water efficient landscaping, including use of native or adapted plantings, minimizes irrigation water demand across the project. Limiting turfgrass and grouping plants that require similar irrigation demands limits excessive irrigation. Supplementing irrigation demands with water reuse strategies can reduce outdoor water demand further. Additional water reduction strategies include using non-potable water for washdown of public spaces including plazas, such as stormwater storage.

Storage & Reuse

Stormwater shall be collected and retained through the green roof systems and potentially cisterns, which will be further analyzed within each building block. This storm water can be filtered and re-used for non-potable applications including cooling tower make-up, irrigation, cleaning, water feature, and flushing demands. Preliminary estimates include approximately 455,000 gallons of site retention potential. Additionally, greywater from showers and lavatories may be filtered and re-used for similar non-potable water applications. Because the blocks are predominately residential buildings, there is substantial potential for greywater reuse on site and this will be further evaluated as blocks are designed.

Key Strategies

- Specify low-flow water fixtures and WaterSense labeled equipment, where applicable
- Evaluate ENERGYSTAR labeled appliances for multi-family units
- Incorporate green roof and bioretention areas to reduce water use demand
- Complete a phase-level whole-site water demand analysis identifying reuse opportunities
- Evaluate irrigation demand and implement only drip systems where needed
- Develop a water meter strategy for different programming types throughout the site

Human Health

Humans spend 90% of our time indoors, and therefore individual human health is directly tied to the health of our buildings.

A 'healthy building' is one that:

- Provides daylight levels to promote circadian rhythms
- Delivers clean and safe potable water to its building's occupants
- Provides fresh, clean air to occupants
- Supports thermal and acoustic comfort for occupants
- Removes waste from the building in an effective and safe manner
- Supports responsible material extraction, manufacturing, and installation practices

Alignment with GBP:

LEED Low-emitting materials credit

Alignment with EAP 2040 Goals:

Reduce GHG emissions from solid waste
Reduce ozone to 70 ppb or lower

Human Health Targets		
Material Sourcing	Block	Material sourcing tracking*
	Block	Low-emitting material tracking
Indoor Environmental Quality	Block	Construction Indoor Air Quality Plans
	Block	100% occupant thermal control (multi-family buildings)*
Waste Management	Site-wide	Ongoing operational waste management planning*
	Block	75% construction waste diversion from new construction*

* voluntary commitment

Strategies in this section are focused on the outcomes most beneficial for humans. Across all stages of the design and construction, there are a growing number of platforms to increase transparency information related to humans. Many technologies and solutions in this space have been evolving for decades, with many feasible 'market-ready' opportunities.

Market-Ready	Innovative	Emerging
UV Disinfection	Material Ingredient Transparency Optimization	Red List Free Materials
MERV 13/HEPA Filtration	Dynamic Indoor Air and Water Quality Sensors	
Material Transparency Reporting	Natural Ventilation	
VOC Restrictions		

Material Sourcing

Building materials are responsible for many adverse environmental issues, including personal illness, habitat and species loss, pollution, and resource depletion. Material selection should aim to remove the worst known offending materials and practices while stressing the importance of availability of healthy building materials through progress in the industry itself. This includes limiting the use of products that off-gas, often contributing to serious health conditions over time, as well as utilizing products that are responsibly sourced with available documentation for proof.



Material Ingredient Reporting

Manufacturers publicly disclose information related to human health and chemical avoidance through third-party certification programs along with the development of their own transparency documents to inform the design team when selecting materials. Many building certification systems have adopted requirements related to specific building material product categories and to require ingredient disclosure/transparency, chemical classes of concern that must be avoided, VOC emissions testing, and 3rd party certifications for optimization. One emerging strategy in the market is specifying Red List Free materials which provides a label verifying the avoidance of the "worst in class" materials, chemicals, and elements known to pose serious risks to human health and the greater ecosystem that are prevalent in the building product industry. Manufacturers release this data through programs like [Red List Free](#), Cradle to Cradle, Greenguard, Floor Score, ANSI/BIFMA e3 Furniture Sustainability Standard, Global Green TAG, and others. Additionally, Environmental Product Declarations (EPDs), Health Product Declarations (HPDs), and Declare Labels are publicly available standardized documents that provide specifiers with material ingredient transparency.



Environmental Product Declarations (EPDs)

An EPD is a standardized document containing information on a product's environmental-related life-cycle impacts. EPDs can be product or company-specific or industry-wide and are typically provided by the manufacturer and are third party verified based on ISO 14045 – known as Type III EPDs. The EPD document is essentially a shorter and more public version of a Life Cycle Analysis Report which is a more in-depth analysis informing about the embodied carbon or supply chain carbon emissions of a product. A specifier can compare EPDs of different products to make informed decisions and responsibly source the products that are installed in a building.



Low-Emitting Materials and Reduced Off-gassing

A Volatile Organic Compound (VOC) is a chemical with a low boiling point, which means that it is likely to evaporate under room conditions. The effects of VOCs on occupant health and wellbeing depend on the concentration of the substance and the individual's sensitivity. High concentrations of VOCs can lead to extreme impacts on health, and lower concentrations can have mild effects. VOCs are often found in finish materials; low-emitting materials do not release these same pollutants into indoor air and do not negatively impact building occupants. Manufacturer transparency and product disclosures are required for responsible material selection. The project will prioritize specifying products that have disclosed material impacts and health impacts, including products compliant with VOC and TVOC emissions standards.



Responsible Sourcing of Raw Materials

Building certification programs, like LEED v4.1, have set benchmarks to ensure responsible sourcing and extraction criteria. The benefits of sourcing raw materials responsibly extend the earth's natural resources from the extracting level throughout manufacturing, and finally to the specifying and purchasing level. This project will prioritize responsible sourcing of raw materials through careful product selection.

- Extended producer responsibility: responsible for the disposal of products through a Take-back-type program.
- Bio-based materials: products that mainly consist of a substance (or substances) derived from living matter (biomass) and either occur naturally or are synthesized, or it may refer to products made by processes that use biomass.
- Wood Products: certified by the Forest Stewardship Council (FSC).
- Material Reuse: includes salvaged, refurbished, or reused products.
- Recycled content: contribution from both pre- and post-consumer materials to reduce the need for virgin materials.

Key Strategies

- Research and prioritize products that provide material ingredient reports
- Define low-emitting material product categories to track at each block
- Research and prioritize products that meet responsible sourcing and extraction criteria
- Implement material ingredient optimization when there are multiple material ingredient reports available for the same product type

Indoor Environmental Quality

The quality of indoor air is dependent upon the air being delivered from outside, and the maintenance of that air once it is circulated throughout the building. Clean air is critical to occupant health. Both indoor and outdoor sources of pollutants (combustion products, material off-gassing, mold, etc.) contribute to a range of negative health outcomes such as asthma, allergies, and other respiratory illnesses. Strategies to mitigate indoor pollutants including carbon dioxide, VOCs, ozone, and carbon monoxide include proper building ventilation.

Indoor Air Quality

Air quality is impacted by the space within and around buildings, and the processes by which air is delivered from the outside and circulated. Improved Indoor Air Quality (IAQ) can be achieved through high performance filtration (MERV 13), IAQ sensors located in regularly occupied spaces, prohibiting smoking within the building and anywhere adjacent to openings, regular maintenance of air filters within air handling units, increased fresh air through ventilation rates, sufficient mechanical system capacity and thoughtful material selection for use in indoor spaces.

Natural ventilation for buildings at the scale of the PRGS site are still considered innovative. This requires additional system evaluation as well as multidisciplinary coordination to reduce the mechanical system sizes – as codes and standards account for human behavior that may result in system inefficiencies when heating or cooling systems may be operational while windows or doors are open.

It is also important to manage IAQ during construction. Proper housekeeping practices, ensuring that absorptive materials are properly weather sealed, and covering HVAC ducts to prevent dust and contamination, are all important to manage daily until the weather barrier is installed.

The use of UV disinfection has recently shifted from an innovative technology to a market-ready solution as a result of the COVID-19 pandemic. This technology can now be implemented into the design of HVAC system coils or into maintenance and operations procedures for increased viral protection in interior spaces.

Lighting

People are at the center of lighting design in buildings. Providing the correct illumination for peak visual performance, and visual comfort creates engaging spaces with appropriate ambiance. Light has also been observed to affect people on multiple levels: feelings – energy, mood, stress levels, functional – alertness and cognitive performance, and longer-term effects such as sleep-wake cycle regulation. A “healthy building” provides quality light to improve productivity, occupant energy levels, and overall mood. Natural lighting reduces needs for artificial lighting, which impacts lighting energy loads as well as heating and cooling loads. Sunlight exposure can be modeled with daylight simulation software to inform design decisions for blocks in the project. Building orientation, massing, and facade design impact solar exposure occupants will have over the course of a day and throughout the seasons. Additionally, daylight sensors and controls may be installed to adjust lighting levels and reduce energy demands.

Thermal and Acoustic Comfort

Similar to lighting quality, thermal comfort of spaces impacts individual building occupant comfort, health, and productivity. Occupant's temperature preference for the environment around them is influenced by temperature, air movement, and humidity. The project will allow occupants to meet these preferences via individual access to a thermostat, operable windows, or other means to control comfort.

Effective acoustic design strategies focused on background noise levels, reverberation time, and sound transmission can improve occupant's comfort and experience in the project's buildings. Specifically, the development is adjacent to Washington Regan National Airport and will require intentional acoustic design to mitigate sound from nearby air traffic.

Key Strategies

- Develop an IAQ plan for construction and operations
- Evaluate IAQ monitoring devices available
- Study operable windows for IAQ benefit and energy impact
- Design for systems with MERV13 filtration

Waste Management

Construction Waste Management

Construction projects are large generators of waste, and account for a significant landfill source. Traditional practice has involved little recycling or reuse of demolition and construction waste. The project will deploy a Construction Waste Management Plan that demonstrates that waste can be removed in a safe and efficient manner. This plan will establish waste diversion goals for the project, and will include designated major waste streams, disposal, and diversion rates.

Solid Waste Management

Solid waste management refers to the safe and effective segregation, handling, collection, and disposal of primary waste streams (residual waste, paper, cardboard, plastic, aluminum, glass, and food waste). Comprehensive solid waste management plans reduce overall waste and ultimately result in carbon reduction by avoiding excessive landfill use. The project will implement a site Waste Management Plan (WMP) that will prioritize user experience by minimizing interactions between visitors and waste and minimizing horizontal and vertical conveyance to increase convenience for residents and tenants. The WMP will promote circular economy through waste reduction, processing, and disposal.

Key Strategies

- Study opportunities for salvaged industrial materials to be reused as public art
- Develop a construction waste management plan for each block development
- Monitor operational waste system capacities and utilization
- Divert construction material waste from regional landfills



Climate Resilience

Adapting to the physical risks presented by climate change is a growing challenge for societies, economies, and communities. The built environment is traditionally designed to mitigate the historical impacts of natural hazards and extreme weather, but climate change presents increased risks and consequences from rising temperatures, more extreme flooding, and extreme weather events that require appropriate adaptation and resilience strategies to reduce risk. In this way, developments can be “future proofed” to minimize impacts from future projected climatic events and reduce damage, disruption, and cost.

The Project Team considered impacts to the overall site and individual buildings related to sea level rise and riverine flooding, extreme precipitation, and extreme heat. The project aims to adapt to climate change impacts and mitigate future risk by considering a variety of resilience strategies to ensure the project minimizes damage, prioritizes the safety of occupants at the site and building level, and is designed for minimal disruption from a climate-induced event.

Alignment with GBP:

No requirement – will review LEED Innovation credit opportunities

Alignment with EAP 2040 Goals:

40% Tree canopy by 2035

Resilience Targets		
Extreme Precipitation	Site-wide	Ongoing monitoring and maintenance of green infrastructure during operations to ensure storm event capacity*
Extreme Heat	Site-wide	100% tree-lined blocks at intervals of 50 ft spacing or less (where not restricted by easements, curb cuts, or other necessary streetscape elements, etc.)
Infrastructure Hardening	Block	100% building systems designed for future climate projections*
	Block	Ongoing monitoring of systems during operations after extreme weather events*

* voluntary commitment

Terminology

100-year Floodplain: the boundary of a flood with a 1% chance (or 1 in 100) of occurring in a given year (also more commonly known as the term Base Flood Elevation for built environment design)

500-year Floodplain: the boundary of a flood with a 0.2% chance (or 1 in 500) of occurring in a given year

Base Flood Elevation: elevation of the base flood (100-year), including wave height

Climate projections: long-term (typically 30 years or more) scientific predictions of future weather conditions at a location

Critical loads: electric loads that are deemed essential for human health and/or building operations which can be served by a backup power source

FEMA Zone AE: base floodplain designation representing 1% chance of annual flooding

FIRM: Flood Insurance Rate Map from FEMA

Heat Emergency Day: daily heat index reaching 95 degrees F or higher

Heat Waves: a series of 3 or more dangerously hot days in a row

NAVD88: North American Vertical Datum of 1988, used as a fixed elevation baseline reference point

Riverine Flooding: typically dry areas flooded by the increased water level of an established river caused by excess freshwater coming from severe or prolonged rain events or snow melt, also called fluvial flooding

Surface Water Flooding: caused by heavy rainfall independent of an overflowing water body, also called pluvial flooding

Urban Heat Island: city and suburban areas that experience warmer temperatures than nearby rural areas

Many of the strategies that enhance resilience are also synergistic with best practices for sustainability issues. Therefore, several of the strategies we are recommending align with recommendations in previous sections of this report. These solutions provide multiple benefits and are considered high priority and high impact due to the performance contributions they may offer the project. Many of these synergistic strategies are identified as the market ready options below. Resilient design is still a relatively new concept, so available solutions are continually evolving. Advances in research related to future frequency and intensity of climate impacts and technical engineering expertise about these more frequent and intense events are influencing innovative projects often seen in pilot phases, and emerging technologies still in beta phase. These resilience strategies are further discussed in this section.

Market-Ready	Innovative	Emerging
Green infrastructure and stormwater detention	Battery backup	On-site water treatment
High reflectance materials	Thermal energy storage	On-site agriculture and food production in urban, mixed-use development
Enhanced tree canopy	Redundant electrical feeds	
Designing building and site systems based on future climate projections	Community resilience hubs	
Backflow prevention	Passive survivability	

Extreme Precipitation

Climate Projections:

Sea Level Rise and Riverine Flooding

As demonstrated in Figure 11, the project is not located within the current FEMA 100-year or 500-year floodplain. Additionally, the project team reviewed potential future flood impacts driven by sea level rise on the tidally influenced Potomac River. According to NOAA's sea level rise viewer, the project site is not anticipated to be impacted by future sea level rise under any future sea level rise scenario (see Figure 12, which shows potential flooding based on a future sea level rise projection of 10 feet).

Precipitation and Stormwater Flooding

The project is also considering potential risks of flooding from more extreme precipitation, including more frequent and intense rainfall events. The number and intensity of extreme precipitation events are expected to increase. These types of extreme rainfall events can saturate urban drainage systems and cause surface water flooding. In Virginia, total annual precipitation shows a slight upward trend since 2000.

Alexandria has experienced more intense and severe storm events since 2019. The City Manager in Alexandria established an interdepartmental task force focused on flooding after three severe storms took place over a 14-month period between 2019 and 2020. The City also installed local rain gauges, including one in Windmill Hill Park, located approximately 1.5 miles south of the PRGS development. Recent flash flooding events affecting the area include an event in September 2020 when rain fell as much as 3 inches in 10 minutes that caused storm sewer surges and sanitary backups⁴.

Key Strategies

- Evaluate below grade building design and programming for flood proofing
- Maximize pervious surfaces throughout the site in conjunction with stormwater design
- Reuse rainfall and stormwater capture on-site to mitigate run-off
- Utilize nature-based solutions like bioretention for water filtration to reduce pollutants
- Evaluate site-wide infrastructure for extreme storm event capacity



Figure 11. FEMA Flood Insurance Rate Map



Figure 12. NOAA SLR 10' Sea Level Rise

⁴ [Severe Flash Flood Events - Alexandria.gov](https://www.alexandria.gov/DocumentCenter/View/10000/Severe-Flash-Flood-Events-Alexandria-gov)

Extreme Heat

Climate Projections

Temperatures have risen 1.5 degrees F since the beginning of the 20th century in Virginia⁵. Heat is one of the deadliest weather concerns and poses an ongoing threat to human health⁶. Increasing air temperatures also are linked to increases in water temperature. These also have impacts on the environment, increasing nuisance pests such as termites, mosquitoes and jellyfish that disrupt ecosystem functions and shifting plant hardiness zones. Based on future climate change projections as shown in Figure 13, it is expected that the project Site will experience higher temperatures and more frequent extreme heat events.

Rising temperatures in Virginia will increase demand on the electricity grid during extreme heat events, which could lead to power outages. This is particularly important for residential buildings, and back-up power for cooling or dedicated cooling respite areas should be evaluated. The enhanced building facades are designed to require less cooling, making the site more able to withstand heat impacts in the case of electricity disruptions.

Urban heat islands are created when buildings, streets, cars, and other hard surfaces emit heat or absorb and reemit heat. This localized amplification of heat impacts occupant comfort and safety; this effect could be compounded by future climate projections for increased temperatures. Heat islands also can increase peak energy demand in summer months and have negative impacts on air and water quality. The redeveloped PRGS site will implement solutions to reduce the existing heat island contributions from the existing site conditions with the implementation of additional nature-based solutions such as green roofs and tree planting, as well as intentional design with higher reflectance materials.

The Northern Virginia Regional Commission (NVRC) has been mapping heat islands in the area to demonstrate the impact of development with higher surface temperatures⁷, as seen in Figure 14.

Passive survivability is considered an innovative solution in this location where systems are designed to maintain critical life-support conditions in the loss of power, heating, or water. In the Virginia climate, this is currently deemed necessary for senior living and healthcare facilities but may change depending on the future climatic shifts.

Key Strategies

⁵ [NCICS Virginia Climate Projections](#)

⁶ [Heat Safety – weather.gov](#)

⁷ [Northern Virginia Urban Heat Islands](#)

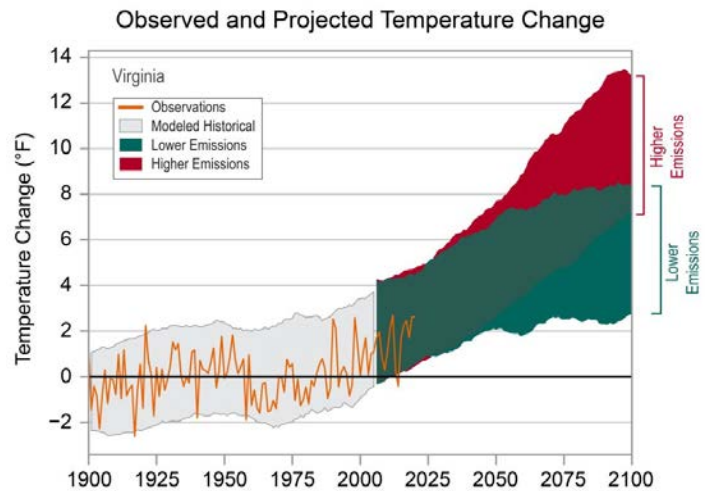

Figure 13. VA Future Climate Projections

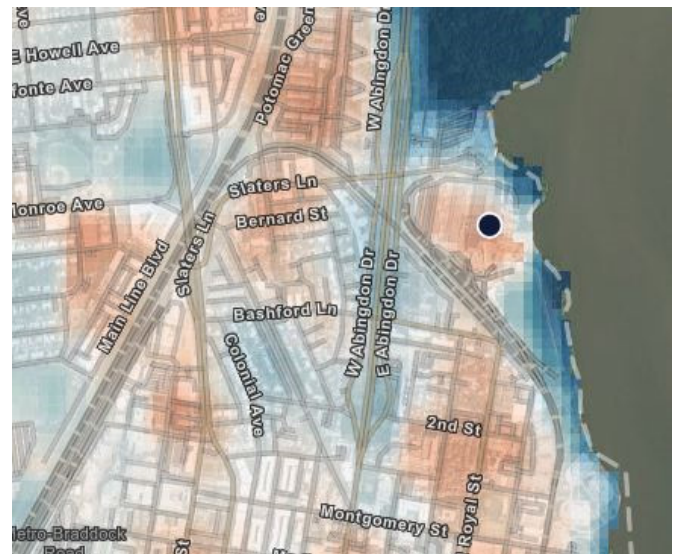

Figure 14. NVRC Urban Heat Island Map

- Use site and roof top materials with higher albedo to help reflect solar energy
- Provide street tree canopy at 30 to 50-foot intervals to provide natural shade and human comfort at the pedestrian scale
- Maximize vegetated areas and nature-based solutions for increased natural areas
- Utilize building massing to provide shade in open spaces
- Implement enhanced envelope strategies to reduce summer cooling demands

Infrastructure Hardening

In addition to design strategies and solutions to prepare for climate change projections, it is important to note that ongoing resilience during operations should also be monitored and tracked.

Strategic System Placement and Waterproofing

Mechanical systems and elevator equipment are often the most expensive equipment in a building. The associated machine rooms, elevator pits and service areas should avoid basement locations, or if those locations cannot be avoided, then additional waterproofing protection should be provided.

During heavy rainfall and flooding events, water pressure in sewer systems can result in backflow into a building. Backflow preventers will be provided on sanitary sewers leaving the site to avoid backup conditions in the case of a city-wide surge. There will also be grease traps installed downstream of commercial kitchens to remove fats, oils, and grease (FOG) from the sanitary sewer to prevent localized sewer backups.

Backup Power and Critical Loads

In cases where there may be regional or local electric grid outages, critical loads can be serviced by dedicated backup power systems. Some examples of these backup loads are: cooling to provide cooling areas during a power outage on an extreme heat day, backup tele-communication capacity to maintain Wi-Fi capability, and/or critical healthcare equipment. Battery systems connected to on-site renewable energy systems can provide these solutions in line with the project's electrification goals. Battery storage can be a phased implementation for backup power, and initial design should evaluate the potential need to ensure electrical panels and circuits are installed for potential future connections. These backup power systems' locations should also be considered in relation to potential stormwater flood zones. The project will evaluate separate critical life support and building functionality systems separately so essential services can be supported by backup generators or battery storage.

Flexible Capacity for Future Demand

Building systems are traditionally designed using historical weather data to size heating and cooling capacity. In combination with an enhanced enclosure and passive solutions to improve overall building performance, heating and cooling system sizing calculations should review future climate projections for the possible impact on demand over the life of the system. Modular solutions that are capable of adding capacity without full replacement will be considered. The project will consider climatic shifts that may require increased heating and cooling system capacity at the site, including additional MEP space for future equipment.

Key Strategies

- Locate important building systems in resilient locations or provide additional waterproofing
- Review critical loads at each block and determine need for dedicated circuits and potential backup power connection
- Analyze climate projections as well as historical weather data for mechanical system sizing at each building
- Evaluate mechanical room and penthouse areas for potential additional system capacity in the future
- Update operational plans to address resilience, as needed

4. Implementation & Reporting

Strategy Implementation

Effective implementation will be required to achieve the ambitious targets in the CDD. The HRP team will use a custom reporting dashboard to track and report progress of site-level, block-level, and external factors that impact performance metrics. Within the dashboard tracking there are strategies that report for design, operations or both phases.

Green Building Rating Systems

The use of third-party green building rating systems will provide independent confirmation of the sustainability performance of the project. LEED for Neighborhood Development will be pursued at the site-level and LEED for Building Design Construction at the block-level – both at a minimum level of Silver certification. The block-level LEED certifications will also serve to fulfill the Alexandria Green Building Policy requirements (current regulations at the time of this document are included in the Appendix). LEED serves as an important tool in the built environment to drive innovation, standardize best practices in sustainability, and provide continual education for a wide range of design and construction professionals working throughout the region.

Reporting Timeline and Dashboard

As defined in the CDD Conditions, reporting will include a Site-level dashboard, Block-level dashboards, and LEED Scorecards. The dashboards will report design strategies and operational metrics in direct control of the PRGS owner or property management team, as well as the external factors such as electric grid emission factors, utility pricing and demand response programs that contribute to the carbon footprint. The table below outlines the anticipated reporting for the CDD Sustainability Conditions.

Target	Site-level Reporting	Block-level Reporting
Condition #139 Target 1 Operational Carbon	LEED ND Scorecard	Block DSUP Submissions
Condition #139 Target 2 On-site Renewables	Infrastructure DSP / Open Space DSUP Submissions	Block DSUP Submissions
Condition #139 Target 3 Embodied Carbon	LEED ND Scorecard	Block DSUP Submissions
Condition #139 Target 4 Electrification	N/A	Block DSUP Submissions
Condition #139 Target 5 Off-site Renewables	N/A	TBD
Condition #142 LEED ND Certification	Final Site Plan	N/A
Condition #143 GBP Compliance	N/A	Block DSUP Submissions
Condition #146 CSS Consistency	N/A	Block DSUP Submissions
Condition #147 Draft Sustainability Scorecards	Final Site Plan	N/A
Condition #148 Sustainability Scorecards	N/A	Block DSUP Submissions & within 1 year of Certificate of Occupancy
Condition #150 EV Chargers	N/A	Block DSUP Submissions
Condition #153 Aggregate Performance Data	Annual Site Operation Performance Report(s)	Annual Building Operation Reports (starting 12 months after first building occupied) for 5 years
Condition #154 & 155 Energy Benchmarking	N/A	ENERGY STAR Portfolio Manager (or equivalent) report at occupancy of each new building and a Sustainability scorecard submitted for first 5 years of occupancy of each building (starting with first building to have full Jan-Dec utility reporting)

Site-level Reporting

Site-level design performance reporting for CSS strategy implementation will happen at the DSUP submission and certificate of occupancy for the waterfront and linear park areas, and operational information will be reported annually for 5 years starting within 1 year after the first certificate of occupancy on the project. Both the design and operational performance scorecards as outlined below will be submitted in conjunction with LEED ND scorecard for each submission until the certification is awarded.

Designed Performance - Site			
Key Targets		DSUP Submission	Certificate of Occupancy
Stormwater management phosphorus reduction		XX%	XX%
LEED ND Points		# Tracking	# Submitted / Award Level
CSS Targets			
Open Space and Biodiversity	5 acres on-site open space	XX acres	XX acres
	20% genus diversity in tree planting	XX%	XX%
Green Infrastructure	2 acres green roof & bioretention systems	XX%	XX%
Circulation & Transportation	4 DASH bus stops with shelters	YES / NO	YES / NO
	2 Bikeshare stations	YES / NO	YES / NO
Renewables	3% on-site renewable energy generation	XX kWh, XX%	XX kWh, XX%
Embodied Carbon	Measure additional horizontal concrete embodied carbon reduction	XX%	XX%
Potable Water Demand	50% outdoor water use reduction	XX%	XX%
Water Storage & Reuse	Quantify water reuse with meters	YES / NO	YES / NO
Waste Management	Ongoing operational waste management planning	XX%	XX%
Extreme Precipitation	Ongoing monitoring green infrastructure during operations for storm event capacity	YES / NO	YES / NO
Extreme Heat	100% tree-lined blocks at intervals of 50 ft spacing or less	YES / NO	YES / NO
Innovative & Emerging Technology Notes			
Site		[note solutions]	[note solutions]
Energy & Carbon		[note solutions]	[note solutions]
Water		[note solutions]	[note solutions]
Human Health		[note solutions]	[note solutions]
Resilience		[note solutions]	[note solutions]
External Factors			
SRVC Electric Grid Emissions		lbs / kWh	lbs / kWh
Electric Utility Price - Residential		\$ / kWh	\$ / kWh
Electric Utility Price - Commercial		\$ / kWh	\$ / kWh

Operational Performance - Site					
Key Targets	Year 1	Year 2	Year 3	Year 4	Year 5
Whole-site EUI Performance	kBtu/ft ²	kBtu/ft ²	kBtu/ft ²	kBtu/ft ²	kBtu/ft ²
On-site Renewable Energy Production	X%	X%	X%	X%	X%
Whole-site Operational Carbon	kg CO ₂ e/m ²	kg CO ₂ e/m ²	kg CO ₂ e/m ²	kg CO ₂ e/m ²	kg CO ₂ e/m ²
Water Reuse	kgal / year	kgal / year	kgal / year	kgal / year	kgal / year
External Factors					
SRVC Electric Grid Emissions	lbs / kWh	lbs / kWh	lbs / kWh	lbs / kWh	lbs / kWh
Electric Utility Price - Residential	\$ / kWh	\$ / kWh	\$ / kWh	\$ / kWh	\$ / kWh
Electric Utility Price - Commercial	\$ / kWh	\$ / kWh	\$ / kWh	\$ / kWh	\$ / kWh

Block-level Reporting

Similar to site-level submissions, the block-level design performance reporting will happen at each block building permit submission and certificate of occupancy, and operational information will be reported annually for 5 years starting within 1 year after the first building certificate of occupancy. Both the design and operational performance scorecards as outlined below will be submitted in conjunction with a LEED BD+C scorecard for each submission until the certification is awarded.

Designed Performance - Blocks			
Key Targets		Building Permit	Certificate of Occupancy
EUI Performance		Baseline: XX kBtu/ft ² Design: XX kBtu/ft ²	Baseline: XX kBtu/ft ² Design: XX kBtu/ft ²
System design changes during construction		N/A	[note any changes from permit]
Annual Operational Carbon Emissions		XX kg CO ₂ e/m ²	XX kg CO ₂ e/m ²
Electrification Exceptions		[note any combustion based systems]	[note any combustion based systems]
LEED Points		# Tracking	# Submitted / Award Level
CSS Targets			
Open Space and Biodiversity	Quantify on-site sequestered carbon from plantings	XX kg CO ₂ e/m ²	XX kg CO ₂ e/m ²
Green Infrastructure	25% of green roof area is intensive with at least 6 species	XX%	XX%
Circulation & Transportation	2% off-street parking spaces with EV charging	XX%	XX%
Operational Carbon	100% electric HVAC & DHW systems	YES / NO	YES / NO
	2021 IECC EUI Targets	XX kBtu/ft ²	XX kBtu/ft ²
Embodied Carbon	10% building embodied carbon reduction	XX%	XX%
Potable Water Demand	40% indoor water use reduction	XX%	XX%
Water Storage & Reuse	Quantify water reuse with meters	YES / NO	YES / NO

Material Sourcing	Material sourcing tracking	YES / NO	YES / NO
	Low-emitting material tracking	# categories tracked	# categories compliant
Indoor Environmental Quality	Construction Indoor Air Quality Plans	YES / NO	YES / NO
	100% occupant thermal control (multi-family buildings)	YES / NO	YES / NO
Waste Management	75% construction waste diversion from new construction	XX%	XX%
Infrastructure Hardening	100% building systems designed for future climate projections	YES / NO	YES / NO
	Ongoing monitoring of operational systems after extreme weather events	YES / NO	YES / NO

Innovative & Emerging Technology Notes

Site	[note systems]	[note systems]
Energy & Carbon	[note systems]	[note systems]
Water	[note systems]	[note systems]
Human Health	[note systems]	[note systems]
Resilience	[note systems]	[note systems]

External Factors

SRVC Electric Grid Emissions	lbs/kWh	lbs/kWh
Electric Utility Price - Residential	\$ / kWh	\$ / kWh
Electric Utility Price - Commercial	\$ / kWh	\$ / kWh

Operational Performance - Blocks

Key Targets	Year 1	Year 2	Year 3	Year 4	Year 5
ENERGY STAR Portfolio Manager Score	XX	XX	XX	XX	XX
EUI Performance	kBtu/ft ²	kBtu/ft ²	kBtu/ft ²	kBtu/ft ²	kBtu/ft ²
Operational Carbon Emissions	kg CO ₂ e/m ²	kg CO ₂ e/m ²	kg CO ₂ e/m ²	kg CO ₂ e/m ²	kg CO ₂ e/m ²
Water Use	kgal / year	kgal / year	kgal / year	kgal / year	kgal / year

External Factors

SRVC Electric Grid Emissions	lbs / kWh	lbs / kWh	lbs / kWh	lbs / kWh	lbs / kWh
Electric Utility Price - Residential	\$ / kWh	\$ / kWh	\$ / kWh	\$ / kWh	\$ / kWh
Electric Utility Price - Commercial	\$ / kWh	\$ / kWh	\$ / kWh	\$ / kWh	\$ / kWh

5. Appendices

I. Project Phasing & Programming

As of the writing of this CSS, the project is described in the CDD by three phases for the purpose of delivering community benefits. Market conditions will inform schedules and timelines associated with actual development.

ROADS & OPEN SPACE PHASING: PHASE 1

NOTE:

- ① GWMP intersections: Operational and signal improvements (subject to coordination with City's traffic operations)
- ② Temporary road: with temporary sidewalks
- ③ Open Space improvements:
 - Interim improvements may be made at these locations until approval from adjacent landowners allows for coordinated permanent improvements to be implemented.
 - Future DSUP's will include detail on proposed final and interim conditions improvements.
- ④ Block A, Pump House and Guard House may be developed with any Phase.
- ⑤ Temporary spine road & Slaters Lane intersection: final geometry and interim finish condition.
- ⑥ Removed locked gate, repair existing stairs and add a bicycle track, extend sidewalk to new driveway.
- ⑦ Temporary bus facilities to be developed as part of Block DSUPs.
- ⑧ Potential future connection to North Pitt St. is subject to cooperation of abutting property owners. The applicant does not control these parcels.

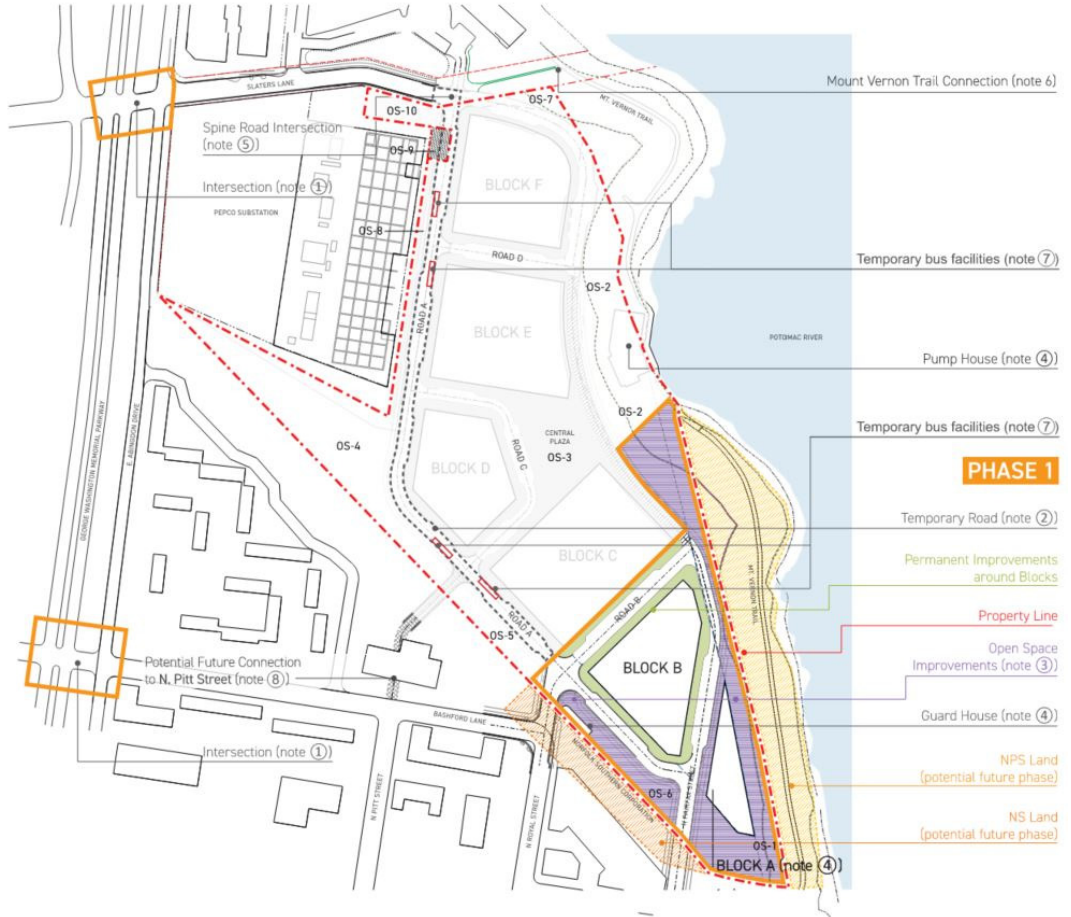

ROADS & OPEN SPACE PHASING: PHASE 2

NOTE:

- ① GWMP intersections: Multimodal operational, physical, and signal improvements identified as part of the Phase 2 MTS
 - to be completed as part of Phase 2, subject to coordination with City and NPS approval
- ② The permanent/final condition of improvements to Slaters Lane may be delayed if potential construction traffic impacts make interim conditions more appropriate subject to the determination and satisfaction of the Director of T&ES.
- ③ Open Space improvements:
 - if it is infeasible for the Waterfront Park area north of the Great Lawn area (exclusive of the Pump House) to be fully completed by the end of Phase 2, a revised schedule may be submitted and approved for park delivery to the satisfaction of the Directors of P&Z and NPS&CA prior to issuance of the first certificate of occupancy for the last building in Phase 2.
 - Interim improvements may be made at these locations until approval from adjacent landowners allows for coordinated permanent improvements to be implemented.
 - Future DSUP's will include detail on proposed final and interim conditions improvements.
- ④ Block A, Pump House and Guard House may be developed with any Phase.
- ⑤ Potential future connection to E/W Abingdon Dr. is subject to cooperation of abutting property owners. The applicant does not control these parcels.
 - Potential improvements to intersections of the George Washington Memorial Parkway will be discussed as part of the overall traffic impact study and will be subject to approval by the National Park Service.
- ⑥ Potential future connection to North Pitt St. is subject to cooperation of abutting property owners. The applicant does not control these parcels.
- ⑦ Temporary road: with temporary sidewalks
- ⑧ Temporary and permanent bus facilities to be developed as part of Block DSUPs

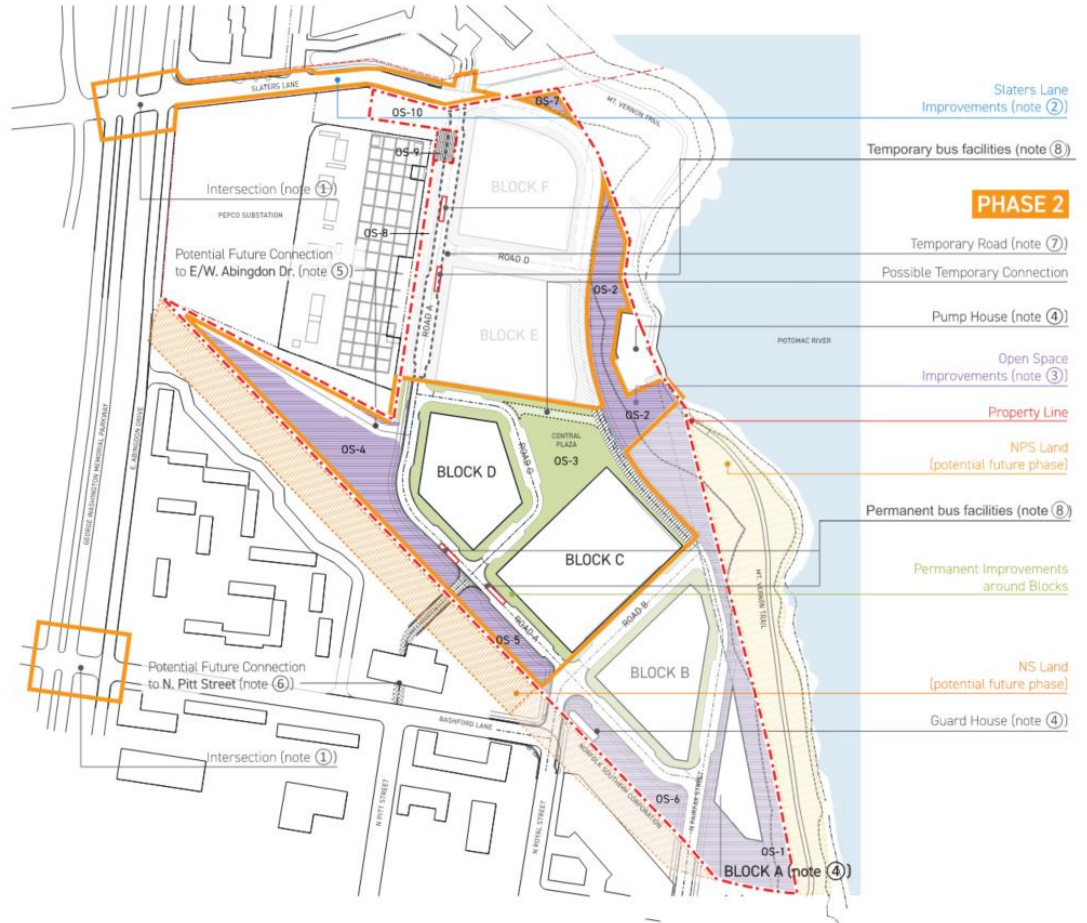

ROADS & OPEN SPACE PHASING: PHASE 3

NOTE:

- ① GWMP intersection improvements completed in previous phases
- ② Slaters Lane improvements: Subject to coordination with City and adjacent landowners
- ③ Open Space improvements:
 - Interim improvements may be made at these locations until approval from adjacent landowners allows for coordinated permanent improvements to be implemented.
 - Future DSUP's will include detail on proposed final and interim conditions improvements.
- ④ Block A, Pump House and Guard House may be developed with any Phase.
- ⑤ Potential future connection to E/W Abingdon Dr. is subject to cooperation of abutting property owners. The applicant does not control these parcels.
 - Potential improvements to intersections of the George Washington Memorial Parkway will be discussed as part of the overall traffic impact study and will be subject to approval by the National Park Service.
- ⑥ Potential future connection to North Pitt St. is subject to cooperation of abutting property owners. The applicant does not control these parcels.
- ⑦ Permanent bus facilities to be developed as part of Block DSUPs

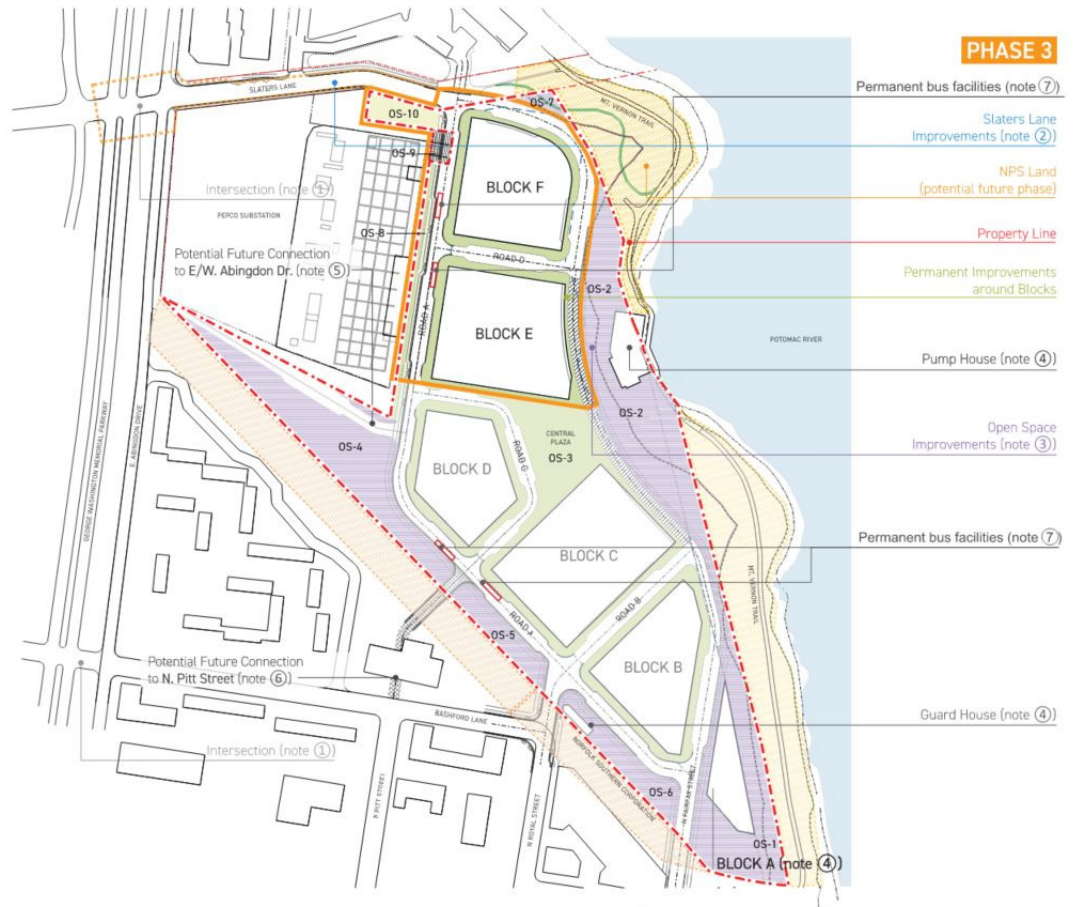

II. CDD Conditions - Sustainability

Concept plan #2021-00004 Coordinated Development Conditions #139 – 156 are Sustainability-focused requirements for the project.

District Carbon Neutrality:

139. The site and each building(s) shall seek to achieve carbon neutrality in compliance with the Old Town North Small Area Plan through application of the targets identified in the Carbon Neutrality Analysis (CNA), dated April 7, 2022, as outlined below:

Target 1

a. Each building(s) shall achieve a minimum 25% reduction in operational carbon emission based on the ASHRAE Standard 90.1-2010 Appendix G – Performance Rating Method baseline established by 2019 Alexandria’s Green Building Policy; or achieve an EUI target based the International Energy Conservation Code (IECC) for climate zone 4A based on building type (e.g. table CC103.1 of the 2021 IECC);. Each building shall comply with the Green Building Policy at time of DSUP submission.

Target 2

b. The site shall achieve a minimum 3% annual on-site renewable energy generation across the CDD area. Prior to the approval of the infrastructure development site plan (DSP), the applicant shall evaluate strategies to increase the targeted 3% on-site energy generation through approaches such as use of public open space, adjoining properties, or other comparable approaches as part of the Coordinated Sustainability Strategy (CSS). These strategies and analysis will be reviewed as part of the infrastructure DSP. As part of each block’s Development Special Use Permit (DSUP) review, the applicant will evaluate strategies to increase the on-site energy generation above 3%.

Target 3

c. Each newly constructed building(s) shall achieve a 10% reduction in embodied carbon compared to industry-standard construction practices. With each preliminary DSUP submission, the Applicant shall provide an estimate of the Embodied Carbon Intensity (ECI) [kgCO₂/m² or lbCO₂/sf], as identified in the CNA, for the proposed redevelopment as part of the development review process. As part of each block’s DSUP, the applicant will evaluate reductions in embodied carbon for associated site improvements.

Target 4

d. Each building(s) and all land use(s) permitted herein shall be solely electric with limited exceptions for allowances for natural gas where electric is not feasible. Natural gas shall be prohibited with limited exceptions for: restaurants and retail uses, emergency generators, common area amenities such as common space grilles and common space fireplaces. For these limited accessory elements, the buildings shall be designed to support low cost and available conversion from fossil fuels to electricity in the future. These limited exceptions shall be re-evaluated with each DSUP submission.

Target 5

e. Off-site renewables shall be utilized towards achieving carbon neutrality, to the extent needed in addition to the targets outlined above, by phase. Off-site renewables may include Power Purchase Agreements (PPAs), Renewable Energy Credits (RECs), and/or other comparable approaches as recommended by staff and approved by the City Council. Generally, the Applicant shall design buildings, infrastructure, and open spaces in a manner to maximize on-site carbon reduction targets and minimize the use of off-site renewables, to the extent feasible. (P&Z) (T&ES) (PC)

140. The applicant shall make all good faith efforts to document and achieve the targets outlined above. The efforts to achieve these targets shall be documented by the applicant and evaluated by staff as part of the development review process. If determined that good faith and reasonable efforts have been made by the applicant to achieve these targets, including consideration of technical and financial feasibility, modifications to these targets may be approved by Planning Commission and City Council as part of the development review process. (P&Z) (T&ES)

141. The applicant, property management entity, BID, or comparable entity shall oversee tracking the targets outlined above. The tools, strategies, and techniques to achieve the targets outlined above shall be submitted with each development special use permit (DSUP) application for each park(s) and/or building(s). (P&Z) (T&ES)

Green Building Certification:

142. Achieve LEED for Neighborhood Development (LEED-ND) Silver Certification or comparable certification for the neighborhood. (P&Z) (T&ES)

143. Comply with the City’s Green Building Policy in effect at the time of DSUP submission. Applicants may use LEED, or equivalent rating systems as identified in the Green Building Policy. (PC)

Coordinated Sustainability Strategy (Sustainability Master Plan):

144. Prior to the 2nd concept submission of the Infrastructure Development Site Plan (Infrastructure DSP), the Applicant shall develop and submit the Coordinated Sustainability Strategy (CSS) and include the evaluation of approaches for on-site energy generation as part of the review of the Infrastructure DSP. This CSS shall be reviewed and endorsed by City Council prior to or concurrent with the approval of the Infrastructure DSP and implemented through DSP/DSUP approvals. If the Council does not endorse the CSS, the applicant shall revise and resubmit the CSS to Council for review and endorsement.

145. The CSS shall outline short-, mid-, and long-term strategies to achieve the five Site and Building performance targets outlined above in addition to other sustainability considerations including:

a. Energy & Resilience Planning/Carbon Reduction strategies as identified in the CNA, including:

- i. District systems
- ii. Building efficiency through energy reduction/EUI targets
- iii. Embodied carbon reduction targets
- iv. On-site/adjoining site energy generation
- v. Electrification strategy
- vi. Off-site renewable/offsets
- b. Indoor Environmental Quality
 - i. Health
 - ii. Ventilation treatment
 - iii. Materials
- c. Site:
 - i. Open Space
 - ii. Stormwater Management
- d. Public Realm/Streetscapes
- e. Water Use Management
- f. Waste Management
- g. Resilience
- h. Reporting & Tracking

146. With each conceptual DSUP submission, the applicant shall demonstrate how the building(s) and site area(s) within that DSUP submission are consistent with the CSS. With each phase, the CSS may be updated to confirm best practices and strategies to achieve the targets to the satisfaction of the Directors of T&ES and P&Z. (P&Z) (T&ES)

147. Prior to the release of the Final Site Plan, the applicant shall provide a draft sustainability strategy scorecard for each DSP/DSUP. The scorecard will demonstrate how the building(s) and site area(s) within that DSP/DSUP submission is consistent with the CSS. (P&Z) (T&ES)

148. Prior to issuance of a building permit for each permitted DSUP, the Applicant shall provide a scorecard reflecting the final design of the building(s) and site area(s) within that permitted DSUP demonstrating consistency with the CSS. A final scorecard of the as-built building(s) and site area(s) within that permitted DSUP shall be provided within the first year from the date of issuance of the certificate of occupancy and shall include information verifying any off-site renewable strategies used.

Electrification:

149. The CSS shall demonstrate consistency with the Environmental Action Plan 2040 targets, goals, and actions to show how electrification is being implemented with limited exceptions for: restaurants and retail uses, emergency generators, common area amenities such as common space grilles and common space fireplaces. For these limited accessory elements, the buildings shall be designed to support low cost and available conversion from fossil fuels to electricity in the future.

150. All new off-street parking shall provide EV (Level II) stations or consistent with City policies which shall be identified and determined during the time of each DSUP submission. (P&Z) (T&ES)

On-site Energy Generation:

151. Rooftops and/or the building facades for each newly constructed building(s) shall be utilized to provide on-site energy generation to the extent feasible and in alignment with the performance targets as outlined above. All buildings shall be designed to be solar ready to be able to handle the equipment after construction. Pull-wire ready conduit shall be provided for potential future rooftop photovoltaic systems. Space shall be provided for solar related electric panel in or near a building electrical closet. Future installation of solar panels and associated infrastructure, beyond the conduit described in this condition, shall be at the sole discretion of the owner. (P&Z) (T&ES)

Recycling/Construction Waste:

152. With each final site plan in the CDD Conceptual Design Plan area, provide information in the plan drawings for the regional construction recycling guidance and certified resources to the extent possible, <https://www.mwcog.org/environment/planning-areas/recyclingand-solid-waste/builders-recycling-guide/builders-recycling/> and/or reuse of the existing building materials as part of the demolition process, including leftover, unused, and/or discarded building materials. (T&ES) (P&Z)

Report & Monitoring:

153. The applicant, owner, property management entity, master HOA, BID or comparable entity shall be responsible for tracking and reporting site-wide sustainability performance as developed and outlined in the Coordinated Sustainability Strategy. The responsible party shall aggregate and verify individual building data annually to demonstrate sitewide performance for the CDD Conceptual Design Plan area as outlined in the Coordinated Sustainability Strategy as buildings within the CDP are constructed.

- a. Reporting shall include:
 - i. Annual LEED scorecards for each building for the first five years of occupancy;
 - ii. An aggregate summary demonstrating the combined building achievements that contribute to achieving the goal of carbon neutrality for the site;
 - iii. Sitewide progress towards achieving carbon neutrality by 2040 for buildings and site targets as identified in the CNA and CSS; and

iv. Any additional updates on sitewide sustainability efforts identified in the CSS. (P&Z) (T&ES).

154. Public benchmarking results for each new building(s) within the CDD plan area will be made available to the City through the ENERGY STAR® Portfolio Manager® platform (or other equivalent systems). This shall be submitted to the satisfaction of the Directors of PZ and T&ES.

155. Monitor the energy usage, report sustainability target performance as outlined in the CSS, and provide tracking documentation following the occupancy of each building(s) system for the first 5 years of occupancy. (P&Z) (T&ES).

156. The applicant may propose additional strategies to the sustainability conditions outlined and these additional sustainability strategies may be incorporated administratively to the satisfaction of the Directors of T&ES and P&Z. (P&Z) (T&ES)

III. City of Alexandria Green Building Policy



CITY OF ALEXANDRIA

2019 Green Building Policy



POLICY STATEMENT:

Green building is a practice that brings environmental and economic benefits to present and future generations. A green building ensures that sustainable standards are adhered to throughout the design and construction processes to lessen the impacts of the building on the local and global environment, resulting in lower operational costs and a healthy indoor environment for building occupants. The standards of the 2019 City of Alexandria Green Building Policy provided herein establish minimum green building practices for new private development and furthers the City's commitment to lead by example through new development and renovation of its own public buildings. In addition to instituting standards to achieve an overall improvement in building performance, this Green Building Policy includes a cutting-edge, directed-use approach that targets the reduction of energy use and mitigating greenhouse gas emissions, increased water efficiency and improved indoor environmental quality in both new private and public buildings. As a result, implementation of this Green Building Policy will contribute to reduced greenhouse gas emissions, conservation of potable water and improved human health in the City of Alexandria.

PERFORMANCE POINTS:

Performance Points are defined as specific minimum credit points each project must achieve within the minimum level of certification for the selected green building rating system. Performance Points are identified within the areas of energy use reduction and greenhouse gas emission reductions, water efficiency, and indoor environmental quality. Projects that use LEED should refer to the LEED Credit Library for the specific criteria of each point. Those who utilize Green Globes, EarthCraft, or National Green Building Standard must comply with the Performance Point overlay criteria in Appendix A, B, and C of this Policy, respectively. To maintain alignment with the intent of this Policy, Performance Points may be adjusted over time to correspond with updates to the rating systems, revisions to the building code, and/or updates to state, federal, or other City policies.

DEVELOPMENT STANDARDS:

New private development, new public development (City-owned buildings, including Alexandria City Public Schools) and major renovations that require a Development Site Plan (DSP) or a Development Special Use Permit (DSUP) are subject to comply with the Green Building Policy. The Green Building Policy is in effect as of March 2, 2020 for DSP and DSUP applications submitted on or after this date.

The 2019 Green Building Policy identifies: 1) the pathways to achieve the City's green building performance standards, including certification through four nationally recognized green building rating systems; 2) a minimum level of green building certification for both private and public developments, and 3) priority "Performance Points" within each rating system that a project is expected to achieve.

RATING SYSTEMS & MINIMUM LEVEL OF CERTIFICATION:

LEED, Green Globes, EarthCraft, and National Green Building Standard are the standard third-party green building rating systems accepted under the Green Building Policy. The minimum level of certification for each rating system is provided on the following pages for both public and private development. The latest version of each rating system at the time of the first Final Site Plan submission shall apply.

In addition to the LEED, Green Globes, EarthCraft, or National Green Building Standard green building rating systems, projects may choose an alternative path for certification through an independent, third-party certifier. The independent, third-party certifier must verify that the performance standards of the Green Building Policy are met.

PUBLIC BUILDING RENOVATIONS:

For renovations of City-owned buildings that do not require a DSP or DSUP, the City will apply LEED Interior Design and Construction (ID+C) and LEED Operations and Maintenance (O&M) rating systems as a guideline for interior design and construction projects and targeted renovations of individual building systems (e.g.: HVAC, roof, windows, plumbing, etc.). Actual third-party certification may be used when technically and financially feasible.

FLEXIBILITY:



Flexibility from the Green Building Policy will be considered on a case-by-case basis. If flexibility is requested, the Director of Planning and Zoning will consider the project size, proposed use and the alternate green building practices the applicant proposes to incorporate into the project to determine if the request is justified. The City will use the data collected from this process over time to establish consistent criteria and thresholds for alternatives to compliance with the Green Building Policy.

STORMWATER	100% of the required stormwater treatment through green infrastructure.
NET ZERO ENERGY	An energy-efficient building where, on a source energy basis, the actual annual delivered energy is less than or equal to the on-site renewable exported energy.

1

2019 GREEN BUILDING POLICY Leadership in Energy and Environmental Design (LEED)											
RATING SYSTEM	MINIMUM LEVEL OF CERTIFICATION		PERFORMANCE POINTS								
			ENERGY USE REDUCTION			WATER EFFICIENCY			INDOOR ENVIRONMENTAL QUALITY		
	Private	Public	POINTS		CREDIT	POINTS		CREDIT	POINTS		CREDIT
			Private	Public		Private	Public		Private	Public	
 LEED BUILDING DESIGN AND CONSTRUCTION (BD+C)	Silver	Gold	5	7	Optimize Energy Performance	4	4	Indoor Water Use Reduction	1	1	Low-Emitting Materials
			2	3	Renewable Energy Production				1	1	Construction Indoor Air Quality Management Plan
			1	1	Advanced Energy Metering ²	1	1	Outdoor Water Use Reduction	1	1	Thermal Comfort
			Optional	3	Enhanced Commissioning				Optional	2	Daylight
			Optional	1	Indoor Air Quality Assessment						

NOTES: 1) Refer to LEED Credit Library for point criteria.
 2) Applies to non-residential projects only (excludes hotels).

2019 GREEN BUILDING POLICY Green Globes											
RATING SYSTEM	MINIMUM LEVEL OF CERTIFICATION		PERFORMANCE POINTS								
			ENERGY USE REDUCTION			WATER EFFICIENCY			INDOOR ENVIRONMENTAL QUALITY		
	Private	Public	POINTS		CREDIT	POINTS		CREDIT	POINTS		CREDIT
			Private	Public		Private	Public		Private	Public	
 GREEN GLOBES  NEW CONSTRUCTION (NC)	2 Green Globes	3 Green Globes	60	68	3.3.1.1 Assessing Energy Performance (Path A, B, or C)	24	24	3.4.1.1 Indoor Water Consumption	11	11	3.7.1.1 Ventilation Air Quality
			9	9	3.3.9.1.1 On-site Renewable Energy Feasibility Study				8	8	3.7.1.2 Air Exchange
			23	23	3.3.9.1.2 On- or Off-site Renewable Energy	6	6	3.2.4.1 Landscape and Irrigation Plan (LIP) by Certified Professional	10	10	3.7.2.1 Volatile Organic Compounds
			18	18	3.3.9.2.1 Off-site Renewable Energy	3	3	3.2.4.1.1 Soil Type, Drainage and Light Conditions			
			32	32	3.3.9.1.2 (Partial) and 3.3.9.2.1 (Partial)	2	2	3.2.4.3.2 Native/Non-invasive Plant Material	5	5	3.1.2.4.1 IAQ During Construction
			Optional	4	3.1.3.2.1.1 HVAC and Refrigeration Systems	3	3	3.2.4.3.3 Turfgrass Minimalized			
			Optional	3	3.1.3.2.1.5 Plumbing						
			Optional	1	3.1.3.2.1.6 Electrical	1	1	3.4.8.2.2 Drip/low Volume Irrigation ²	Optional	3	3.1.2.4.2 IAQ of Occupied Areas During Construction
			Optional	1	3.1.3.2.1.7 Lighting				2-12	2-12	3.7.4 Thermal Comfort
			Optional	1	3.1.3.2.1.8 Building Automation						
			Optional	1	3.1.3.3.1 Training Requirements	1	1	3.4.8.2.3 WaterSense/SWAT/Smart Control System ³	Optional	8	3.3.5.4 Daylighting
			Optional	6	3.1.3.4.1 Operations and Maintenance Manuals				Optional	7	3.7.3.1.1 Daylighting
			METERING, MEASUREMENT AND VERIFICATION ²						Optional	2	3.1.2.4.1 IAQ During Construction Indoor Air Quality Test Pathway
			1	1	3.3.3.1.1.1 Electricity	0.5	0.5	3.4.8.2.4 Regulation of Precipitation Rate on Sprinkler ³	Optional	7	3.7.3.1.1 Daylighting
			1	1	3.3.3.1.1.2 Heating Fuels						
1	1	3.3.3.1.1.4 Other, with description (as applicable)									
0.5 - 3	0.5 - 3	3.3.3.1.2 Sub-metering (as applicable)	0.5	0.5	3.4.8.2.5 Swing Joints/Flex Pipes on Irrigation Heads ³	Optional	2	3.1.2.4.1 IAQ During Construction Indoor Air Quality Test Pathway			

NOTES: 1) Refer to Appendix A: "City of Alexandria, VA Performance Design Targets – Directed Use Criteria ("Performance Points") for Green Globes" for Performance Point criteria.
 2) Applies to non-residential projects only (excludes hotels).
 3) Credit is only applicable if an automated irrigation system is installed.

2019 GREEN BUILDING POLICY EarthCraft Multifamily											
RATING SYSTEM	MINIMUM LEVEL OF CERTIFICATION		PERFORMANCE POINTS								
			ENERGY USE REDUCTION			WATER EFFICIENCY			INDOOR ENVIRONMENTAL QUALITY		
	Private	Public	POINTS		CREDIT	POINTS		CREDIT	POINTS		CREDIT
			Private	Public		Private	Public		Private	Public	
	Gold	N/A	2-5	N/A	IN 1.1 Solar, Micro-hydro, Wind Electric IN 1.2 Solar-ready Design IN 1.3 Solar Electric System or IN 1.5 Common Areas Solar Electric Use	9-14	N/A	INDOOR WATER USE WE 1.2 Water Treatment WE 1.3 Water Softeners WE 1.4 Storage WE 1.5.1 WaterSense Toilet WE 1.5.2 WaterSense Urinal WE 1.5.3 WaterSense Lavatory Faucet WE 1.5.4 WaterSense Showerhead WE 1.6 Toilet < 1.1 gallon/flush	4	N/A	IAQ 2.7 VOC Materials and IAQ 2.12 Zero Carpet in Units
			1-2	N/A	EO 3.4 Light Commercial Community Center (as applicable) or EO 3.5 Light Commercial Ready Spaces (as applicable)	5-10	N/A	WE 1.2 Water Treatment WE 1.3 Water Softeners WE 1.5.1 WaterSense Toilet WE 1.5.2 WaterSense Urinal WE 1.5.3 WaterSense Lavatory Faucet WE 1.5.4 WaterSense Showerhead 40% Reduction from Baseline	2	N/A	BE 3.15 Insulation BE 3.16 Walls BE 3.17 Exterior Insulation BE 3.18 Ceilings BE 3.19 Attic Kneewalls or BE 3.20 Insulate Roofline
			Optional	N/A	COMMISSIONING EO 2.3 Pre-occupancy Briefing	4-9	N/A	OUTDOOR WATER USE WE 2.4 Turf <40% WE 2.5 Vegetate 4:1 Slopes WE 2.7 Drought Tolerant/Native Plants WE 2.8 Guidebook and WE 2.6 Irrigation ²	1	N/A	IAQ 2.9 Pre-occupancy Flush
			Optional	N/A	EO 2.4 Post-occupancy Briefing						
			Optional	N/A	EO 2.5 Environmental Management and Building Maintenance Guidelines for Staff	3	N/A	-OR- WE 2.10.1 Greywater Irrigation ²	1	N/A	IAQ 2.9 Pre-occupancy Flush
			Optional	N/A	High-rise Addendum	-OR-					
			Optional	N/A	METERING IN 1.7.12 Months Post-Construction Energy Monitoring	3	N/A	WE 2.10.2 Rainwater Irrigation ²			

NOTES: 1) Refer to Appendix B-1: "City of Alexandria, VA Performance Design Targets – Directed Use Criteria ("Performance Points") for Earthcraft Multifamily (ECMF)" for Performance Point criteria.
2) Credit is only applicable if an automated irrigation system is installed.

2019 GREEN BUILDING POLICY EarthCraft Light Commercial														
RATING SYSTEM	MINIMUM LEVEL OF CERTIFICATION		PERFORMANCE POINTS											
			ENERGY USE REDUCTION			WATER EFFICIENCY			INDOOR ENVIRONMENTAL QUALITY					
	Private	Public	POINTS		CREDIT	POINTS		CREDIT	POINTS		CREDIT			
			Private	Public		Private	Public		Private	Public				
	Certified	Gold	1	1	BE 1A Envelope Air Tightness Test	3	3	INDOOR WATER USE WE 1A High Efficiency Toilets WE 1B Pint Flush or Waterless Urinals WE 1C Automatic Faucets, and/or WE 1D High Efficiency Showerheads	2	2	IEQ 5 Certified Flooring IEQ 6 Composite Wood or IEQ 7 Product Transparency			
			1	1	ES 5 High Performance Duct System									
			1	1	IN 1 Renewable Energy Installation				1	1	IEQ 1 Decoupled Ventilation IEQ 2 (DCV) IEQ 3 Air Filtration Media or IEQ 4 Radon Exposure Prevention			
			2	2	IN 2 Renewable Energy Procurement									
			Optional	3	COMMISSIONING EO 1 Building Systems Commissioning				Optional	1	BE 7 Daylighting Design Strategies			
			PR ⁴	PR ⁴	METERING EO R1 Utility Tracking							3	3	OUTDOOR WATER USE WE 2 Landscape Plan WE 3 Efficient Irrigation System and/or No Irrigation and/or WE 4 Non-potable Water Source Used for Irrigation ³

NOTES: 1) Refer to Appendix B-2: "City of Alexandria, VA Performance Design Targets – Directed Use Criteria ("Performance Points") for Earthcraft Light Commercial (ECLC)" for Performance Point criteria.
2) Applicable to commercial buildings, schools and public facilities up to 80,000 square feet.
3) Credit is only applicable if an automated irrigation system is installed.
4) PR = Program Requirement; no points assigned.

2019 GREEN BUILDING POLICY National Green Building Standard (NGBS)														
RATING SYSTEM	MINIMUM LEVEL OF CERTIFICATION		PERFORMANCE POINTS											
			ENERGY USE REDUCTION			WATER EFFICIENCY			INDOOR ENVIRONMENTAL QUALITY					
	POINTS		CREDIT	POINTS		CREDIT	POINTS		CREDIT					
	Private	Public		Private	Public		Private	Public						
 NATIONAL GREEN BUILDING STANDARD (NGBS)	SILVER	N/A	66	N/A	702 Performance Path	39 + Additional Documentation of LEED Water Tool Results to demonstrate 40% reduction	N/A	802.2 Water conserving Appliances 802.4 Showerheads 802.5 Faucets	6 - 18 (depending on credits selected)	N/A	Achieve listed number of points for at least two of the following: 901.4 Wood Materials: 10 points 901.7 Floor Materials: 8 points 901.9 Interior Architectural Coatings: 8 points 901.10 Interior Adhesives and Sealants: 5 points 901.11 Insulation: 4 Points 901.12 Furniture and Furnishings: 2 points			
			2 per kW+ Documentation on that onsite generation is projected to meet at least 5% of energy demand	N/A	706.5 On-Site Renewable Energy System. 706.2 Renewable Energy Service Plan. Additional non-NGBS documentation required: Proof that the planned on-site renewable energy will exceed 5% of planned demand			Additional non-NGBS Documentation Required: LEED Water Tool Outputs - Demonstrate a 40% reduction in indoor water use relative to baseline water use using the LEED Water Tool	9 points required for multi-family 7 points required for townhomes		902.2 Building Ventilation Systems - 2 points 902.4 HVAC System Protection - 3 points 904.1 Indoor Air Quality (IAQ) During Construction - 2 points 901.15 Non-Smoking Areas - 2 points (only applicable to multi-family projects)			
			1 for multifamily projects	N/A	705.7 Submetering System			5	N/A		503.5 Landscape Plan	9	N/A	903.3 Relative Humidity 905.1 Humidity Monitoring System
			14 for multifamily projects	N/A	705.6 Installation and Performance Verification			Additional Documentation of WaterSense Water Budget tool to demonstrate 50% reduction	N/A		802.6.1/2/3/4 Irrigation Systems Additional non-NGBS Documentation Required: EPA WaterSense Water Budget Tool - Demonstrate at least a 50% reduction in irrigation water demand using the Water Budget Tool	Optional Optional	N/A	901.1 Space and Water Heating Options 902.2 Building Ventilation Systems 902.3 Radon Reduction Measures 904.2 Indoor Air Quality (IAQ) Post Completion 904.12 Indoor Air Quality (IAQ) Post Completion - 3 points

NOTES: 1) Refer to Appendix C: "City of Alexandria, VA Performance Design Targets – Directed Use Criteria ("Performance Points") for National Green Building Standard (NGBS)," for Performance Point criteria.
 2) Applicable to residential projects only. Does not apply to public projects.

APPENDIX A: CITY OF ALEXANDRIA, VA PERFORMANCE DESIGN TARGETS – DIRECTED USE CRITERIA (“PERFORMANCE POINTS”) FOR **GREEN GLOBES FOR NEW CONSTRUCTION (NC)**.

For additional information, refer to the [Green Globes for New Construction Technical Reference Manual v1.50](#).

As part of achieving a minimum certification of Two Green Globes for private projects, or Three Green Globes for public projects in the City of Alexandria, VA, Green Globes projects must fulfill the following Green Globes criteria:

ENERGY

Energy Reduction for Private Projects

Green Globes Criteria: 3.3.1.1: All private projects must achieve a minimum of 60 points under Pathways A, B, or C, identified in criteria 3.3.1.1 for an EUI > 30% (60 points)

Energy Reduction for Public Projects

Criteria 3.3.1.1: All projects must achieve a minimum of 68 points under Pathways A, B, or C, identified in criteria 3.3.1.1 for an EUI \geq 35% (68 points)

Renewable Energy for Private Projects

3.3.9.1.1.: Perform feasibility study under criteria 3.3.9.1.1 to determine whether 5% onsite renewable energy equipment or 40% off-site renewable energy equipment is achievable for the project (9 points)

Per the result of the feasibility study, achieve these criteria by following one of the three paths below:

PATH 1: Criteria 3.3.9.1.2: Installation of 5% or greater **on-site** renewable energy; or installation of 40% or greater **off-site** renewable energy. (23 points)

OR

PATH 2: Criteria 3.3.9.2.1: Procurement of RECs and/or offsets for 200% of building energy for a minimum of three years (18 points)

OR

PATH 3: Achieve Criteria 3.3.9.1.2 for installation of either 2% on-site or 20% off-site renewable energy equipment (14 points) **AND** achieve 3.3.9.2.1 for procurement of RECs and/or offsets for 100% of building energy for minimum of three years (18 points).

Renewable Energy for Public Projects

3.3.9.1.1.: Perform feasibility study under criteria 3.3.9.1.1 to determine whether a minimum of 10% onsite renewable energy equipment or 60% off-site renewable energy equipment is achievable for the project (9 points)

Per the result of the feasibility study, achieve these criteria by following one of the three paths below:

PATH 1: Criteria 3.3.9.1.2: Installation of 10% or greater **on-site** renewable energy; or installation of 60% or greater **off-site** renewable energy (23 points)

OR

PATH 2: Criteria 3.3.9.2.1: Procurement of RECs and/or offsets for 200% of building energy for a minimum of six years (18 points)

OR

PATH 3: In cases where the onsite/offsite renewable energy goals may be partially achieved, Criteria 3.3.9.1.2 for installation of either a minimum of 5% on-site or 30% off-site renewable energy equipment (14 points) **AND** achieve 3.3.9.2.1 for procurement of RECs and/or offsets for 100% of building energy for minimum of six years (18 points).

Commissioning for Public Projects (Optional for Private Projects)

The City of Alexandria recommends that all private projects attempt to include Commissioning whenever possible, although it is not required for private projects. Public projects must fulfill commissioning criteria related to mechanical systems, plumbing, and electrical, specifically by utilizing the following Green Globes Criteria:

- 3.1.3.2.1.1., HVAC and refrigeration systems (4 points)
 - 3.1.3.2.1.5., Plumbing (3 points)
 - 3.1.3.2.1.6., Electrical (1 point)
 - 3.1.3.2.1.7., Lighting (1 point)
 - 3.1.3.2.1.8., Building automation (1 point)
 - 3.1.3.3.1., Training requirements (1 point)
 - 3.1.3.4.1., Operations and Maintenance manuals (6 points)
- Total points: (17 points)

Advanced Energy Metering for Public and Private Projects*

All applicable points in the following Green Globes Criteria related to whole building/significant use metering must be fulfilled (*as applicable to the building's systems*):

- 3.3.3.1.1.1., Electricity (1 point)
 - 3.3.3.1.1.2., Heating Fuels (1 point)
 - 3.3.3.1.1.3., Steam (1 point)
 - 3.3.3.1.1.4., Other, with description (1 point)
- Total possible points for this section: (4 points)

And, for the following end uses making up over 10% of the building load, *as applicable to the building*:

- 3.3.3.1.2.1., Sub-metering on lighting and lighting controls by floors or zones (0.5 points)
- 3.3.3.1.2.2., Sub-metering on plug loads by floor or zones (0.5 points)
- 3.3.3.1.2.3., Sub-metering on major electric HVAC equipment (0.5 points)
- 3.3.3.1.2.4., Sub-metering on chilled water generation (0.5 points)
- 3.3.3.1.2.5., Sub-metering for onsite renewable energy generation (0.5 points)

3.3.3.1.2.6., Sub-metering for heating water or steam generation (0.5 points)

Total possible points for this section: (3 points)

**Applies to non-residential projects only, excluding hotel projects. Such projects are excluded from being required to comply with these criteria, although the City of Alexandria urges projects to consider compliance with these criteria, where possible.*

WATER EFFICIENCY

Indoor Water Use for Public and Private Projects

The following Green Globes Criteria must be fulfilled:

3.4.1.1, Projected water consumption determined to be less than the baseline by a minimum of 40% (24 points)

Outdoor Water Use for Public and Private Projects

The following Green Globes Criteria must be fulfilled through a project achievements in both landscaping (Site), and irrigation systems (Water) performance:

3.2.4.1., Landscape Irrigation Plan (LIP) by Landscape Architect (6 points)

3.2.4.1.1., LIP for soil type, drainage and light (3 points)

3.2.4.3.2., Native/Non-invasive plants (2 points)

3.2.4.3.3., Turf grass minimalized (3 points); and

-The following criteria and points are only applicable if an automated irrigation system is installed-

3.4.8.2.2., Drip/low volume irrigation (1 point)

3.4.8.2.3., Watersense/SWAT/Smart Control system (1 point)

3.4.8.2.4., Regulation of precipitation rate on sprinkler systems (0.5 point)

3.4.8.2.5., Swing joints/Flex pipes on irrigation heads (0.5 point)

INDOOR ENVIRONMENTAL QUALITY

Indoor Environmental Quality for Public and Private Projects

The following Green Globes Criteria must be fulfilled:

3.1.2.4 IAQ During Construction (5 points maximum)

3.3.5.4 Daylighting (8 points) (public buildings only)

3.7.3.1.1 Daylighting (7 points) (public buildings only)

3.7.1.1 Ventilation Air Quantity (11 points)

3.7.1.2 Air Exchange (8 points)

3.7.2.1 Volatile Organic Compounds (10 points)

3.7.4 Thermal Comfort (up to 12 points depending on building use/purpose)

Indoor Air Quality for Public Projects

3.1.2.4.1 IAQ During Construction: Indoor Air Quality Test pathway (2 points)

3.1.2.4.2 IAQ of Occupied Areas During Construction (3 points)

APPENDIX B-1: CITY OF ALEXANDRIA, VA PERFORMANCE DESIGN TARGETS ("PERFORMANCE POINTS") – DIRECTED USE CRITERIA FOR EARTHCRAFT MULTIFAMILY (ECMF).

For additional information, refer to the [EarthCraft Multifamily Technical Guidelines](#).

The EarthCraft Multifamily rating system is not applicable to public projects. For private projects, as part of achieving the minimum certification requirements for EarthCraft Gold, the following must also be completed projects in the City of Alexandria:

ENERGY:

Renewable Energy

Achieve one of the four paths below:

IN 1.1: Solar, micro-hydro, or wind electric system (4 points)

OR

IN 1.2: Solar-ready design (2 points)

OR

IN 1.3: Solar electric system (5 points)

OR

IN 1.5: Common areas use solar electric system (4 points)

Community Buildings/Commercial Spaces (as applicable for mixed-use developments with ground floor commercial use and multifamily units above).

Achieve one of the two following credits:

EO 3.4: EarthCraft Light Commercial for community center (2 points)

OR

EO 3.5: EarthCraft Light Commercial ready spaces (1 point)

Commissioning (optional)

Achieve the following credits:

EO 2.3: Provide pre-occupancy briefing for tenant (2 points)

EO 2.4: Project participates in post-occupancy debriefing (2 points)

EO 2.5: Environmental management and building maintenance guidelines for staff (2 points)

Achieve all applicable items on the High Rise Addendum (applicable for low-, mid-, and high-rise projects)

Advanced Metering (optional)

Achieve the following credit:

IN 1.7: Developer contracts for at least 12 months post-construction energy monitoring (6 points)

APPENDIX B-1: "PERFORMANCE POINTS" FOR EARTHCRAFT MULTIFAMILY (ECMF).

WATER EFFICIENCY

Indoor Water Use

Achieve one of the two paths below:

PATH 1: Earn a minimum of 9 points and up to 14 points from any combination of the following credits:

- WE 1.2: Water treatment system NSF certified (2 points)
- WE 1.3: Water softeners certified to NSF/ANSI Standard 44 (2 points)
- WE 1.4: Store < .5 gallons of water between water heater and furthest fixture (2 points)
- WE 1.5.1: WaterSense toilet (2 points); WE 1.5.2: WaterSense urinal (1 point)
- WE 1.5.3: WaterSense lavatory faucet (1 point);
- WE 1.5.4: WaterSense showerhead (2 points) and
- WE 1.6: Toilet < 1.1 gallon/flush (2 points)

OR

PATH 2: Earn a minimum of 5 points and up to 10 points from any combination of the following credits:

- WE 1.2: Water treatment system NSF certified (2 points)
- WE 1.3: Water softeners certified to NSF/ANSI Standard 44 (2 points)
- WE 1.5.1: WaterSense toilet (2 points)
- WE 1.5.2: WaterSense urinal (1 point);
- WE 1.5.3: WaterSense lavatory faucet (1 point)
- WE 1.5.4: WaterSense showerhead (2 points); and demonstrate a 40% reduction from the baseline through the Indoor Water Use Calculator

Outdoor Water Use

Achieve one of the three paths below:

PATH 1: Earn a minimum of 4 points and up to 9 points from any combination of the following credits:

- WE 2.4: Turf <40% of landscaped area (2 points);
- WE 2.5: Vegetate slopes exceeding 4:1 (1 point);
- WE 2.7: Drought-tolerant/native landscaping turf and plants (1 point);
- WE 2.8: Xeriscape guidebook given to property manager or owners (1 point); and
- WE 2.6: Irrigation (4 points) (WE 2.6 is only applicable if automated irrigation is installed)

OR

PATH 2: WE 2.10.1: Greywater irrigation system (3 points) (only applicable if automated irrigation is installed)

OR

PATH 3: WE 2.10.2: Rainwater irrigation system (3 points) (only applicable if automated irrigation is installed)

INDOOR ENVIRONMENTAL QUALITY

Achieve the following:

Earn a total of 4 points between IAQ 2.7: Certified low or no VOC materials and IAQ 2.12: No carpet in all units

AND

Earn a total of 2 points from any combination of the following credits:

- BE 3.15: Insulate with foam insulation
- BE 3.16: Walls
- BE 3.17: Continuous exterior insulation
- BE 3.18: Ceilings
- BE 3.19: Attic kneewalls, and/or
- BE 3.20: Insulate roofline

AND

Achieve IAQ 2.9: Pre-occupancy flush (1 point)

APPENDIX B-1: 'PERFORMANCE POINTS' FOR EARTHCRAFT MULTIFAMILY (ECMF).

APPENDIX B-2: CITY OF ALEXANDRIA, VA PERFORMANCE DESIGN TARGETS ("PERFORMANCE POINTS") – DIRECTED USE CRITERIA FOR EARTHCRAFT LIGHT COMMERCIAL (ECLC) v2.1.

For additional information, refer to the [EarthCraft Light Commercial Technical Guidelines](#).

As part of achieving the minimum certification requirements for EarthCraft Light Commercial (ECLC) Certified for private developments and ECLC Gold for public developments, the following must also be completed for projects in the City of Alexandria:

ENERGY:

Energy for Private Projects:

Achieve the following credits:

BE 1A: Measured ELR75 is 0.30 or better (1 point)

AND

ES 5: High Performance Duct System (1 point)

AND

IN 1: Renewable Energy Installation of 5% or greater on-site renewable energy; or installation of 40% or greater off-site renewable energy. (1 point)

OR

IN 2: Renewable Energy Procurement of RECs and/or offsets for 200% of building energy for a minimum of three years (2 points)

Energy for Public Projects:

Achieve the following credits:

BE 1A: Measured ELR₇₅ is 0.30 or better (1 point)

AND

ES 5: High Performance Duct System (1 point)

AND

IN 1: Renewable Energy Installation of 10% or greater **on-site** renewable energy; or installation of 60% or greater **off-site** renewable energy. (1 point)

OR

IN 2: Renewable Energy Procurement of RECs and/or offsets for 200% of building energy for a minimum of six years (2 points)

APPENDIX B-2: "PERFORMANCE POINTS" FOR EARTHCRAFT LIGHT COMMERCIAL (ECLC)

Commissioning for Public Projects (Optional for Private Projects)

Achieve the following credit:

EO 1: Building Systems Commissioning (3 points)

WATER USE:

Indoor Water Use

Earn a total of 3 points from any combination of the following credits:

- WE 1A: High Efficiency Toilets
- WE 1B: Pint Flush or Waterless Urinals
- WE 1C: Automatic Faucets and/or
- WE 1D: High Efficiency Showerheads

Outdoor Water Use

Earn a total of 3 points from any combination of the following credits:

- WE 2: Xeriscape Landscape Plan
- WE 3: Efficient Irrigation System or No Irrigation System and/or
- WE 4: Non -Potable Water Source Used for Irrigation (WE 4 is only applicable if an automated irrigation system is installed)

INDOOR ENVIRONMENTAL QUALITY

Achieve 4 points from the following credits:

Earn a total of 1 point from any combination of the following credits:

- IEQ 1: Decoupled Ventilation
- IEQ 2: Demand Control Ventilation (DCV)
- IEQ 3: Air Filtration Media: MERV 11 or Higher or
- IEQ 4: Radon Exposure Prevention

AND

Earn a total of 2 points from any combination of the following credits:

- IEQ 5: Certified Flooring
- IEQ 6: Composite Wood Contains No Added Urea-Formaldehyde or
- IEQ 7: Product Transparency Label Material Selection

AND

Earn 1 point from BE 7: Daylighting Design Strategies

APPENDIX C: CITY OF ALEXANDRIA, VA PERFORMANCE DESIGN TARGETS – DIRECTED USE CRITERIA (“PERFORMANCE POINTS”) FOR NATIONAL GREEN BUILDING STANDARD (NGBS).

For additional information, refer to the [2020 National Green Building Standard Manual](#).

The National Green Building Standard rating system is not applicable to public projects or commercial projects. For private residential projects, as part of achieving the minimum certification requirement of Silver for National Green Building Standard, the following must also be completed projects in the City of Alexandria:

ENERGY

Optimize Energy Use:

The following criteria must be fulfilled:

- All projects must achieve a minimum of 66 points under the 702 Performance Path. Neither the prescriptive path nor the ERI target path should be used for compliance with the Alexandria Green Building Standard (66 points)

On-Site Renewables:

The on-site renewables must be 5% of the total site energy to meet the Alexandria Green Building Standard. Points allotted are 2 points kW+. The following criteria must be fulfilled:

- 706.5 On-Site Renewable Energy System
- 706.2 Renewable Energy Service Plan
- Additional non-NGBS documentation required: Proof that the planned on-site renewable energy will exceed 5% of planned demand

Measurement and Verification:

The following criteria must be fulfilled:

- Earn 1 point under 705.7 Submetering System (1 point)

Enhanced Commissioning:

The following criteria must be fulfilled:

- Projects must achieve 14 points under 706 Installation and Performance Verification (14 points)

WATER EFFICIENCY

NGBS does have a performance rating for water efficiency under section 804, using Water Rating Index (WRI) methodology. However, the WRI methodology combines indoor and outdoor water use into a single metric.

- 904.1 Indoor Air Quality (IAQ) During Construction (2 points)
- 901.15 Non-Smoking Areas (2 points)

Thermal Comfort:

Achieve the listed number of points for each of the following categories:

- 903.3 Relative Humidity (7 points)
- 905.1 Humidity Monitoring System (2 points)

Daylighting (Optional):

There is no specific daylighting requirement in NGBS.

Private Projects Enhanced Indoor Air Quality Strategies (Optional):

- 901.1 Space and Water Heating Options
- 902.2 Building Ventilation Systems
- 902.3 Radon Reduction Measures

Indoor Air Quality Assessment (Optional):

- 904.2 Indoor Air Quality (IAQ) Post Completion
- 904.12 Indoor Air Quality (IAQ) Post Completion (3 points)

Indoor Water Use:

In addition to achieving the minimum 39 required points under Water Efficiency for NGBS Silver (across indoor and outdoor use), projects must use the LEED Water Tool to calculate their design water baseline and design water savings and demonstrate a projected reduction of 40% over the baseline.

The following criteria must be fulfilled:

- 802.2 Water-conserving Appliances
- 802.4 Showerheads
- 802.5 Faucets
- Additional non-NGBS Documentation Required: LEED Water Tool Outputs - Demonstrate a 40% reduction in indoor water use relative to baseline water use using the LEED Water Tool

Outdoor Water Use:

In addition to achieving the minimum required 39 required points under Water Efficiency for NGBS Silver (across indoor and outdoor use), projects must use the EPA WaterSense Water Budget to calculate their irrigation water demand baseline, demonstrate a projected reduction of 50% relative to the baseline.

The following criteria must be fulfilled:

- 503.5 Landscape Plan
- 802.6.1/2/3/4 Irrigation Systems
- Additional non-NGBS Documentation Required: EPA WaterSense Water Budget Tool - Demonstrate at least a 50% reduction in irrigation water demand using the Water Budget Tool

INDOOR ENVIRONMENTAL QUALITY

Low Emitting Materials:

Achieve at least the applicable maximum number of points, as listed, *in at least two* of the following six categories:

- 901.4 Wood Materials (10 points)
- 901.7 Floor Materials (8 points)
- 901.9 Interior Architectural Coatings (8 points)
- 901.10 Interior Adhesives and Sealants (5 points)
- 901.11 Insulation (4 points)
- 901.12 Furniture and Furnishings (2 points)

Indoor Air Quality Construction Management:

Achieve the listed number of points for each of the following categories. A total of 9 points are required for multi-family and 7 points required for townhomes.

- 902.2.3 or 902.2.4: Building Ventilation Systems. Indicating MERV Filters must be at least MERV 8 (2 points)
- 902.4 HVAC System Protection (3 points)

IV. LEED Preliminary Scorecards

LEED scorecards will be used to track sustainability strategies being implemented across the project and provide external third-party independent verification.

The preliminary LEED for Neighborhood Development (ND) scorecard is shown below, outlining a preliminary pathway to achieving the minimum 50-point threshold for Silver level certification.



LEED v4 for Neighborhood Development Plan Preliminary Checklist

Project Name: Potomac River Generating Station Site
Date: January 2023

Yes	?	No			Yes	?	No				
12	16	0	Smart Location & Linkage		28	15	11	5	Green Infrastructure & Buildings	31	
Y			Prereq	Smart Location	Required	Y			Prereq	Certified Green Building	Required
Y			Prereq	Imperiled Species and Ecological Communities	Required	Y			Prereq	Minimum Building Energy Performance	Required
Y			Prereq	Wetland and Water Body Conservation	Required	Y			Prereq	Indoor Water Use Reduction	Required
Y			Prereq	Agricultural Land Conservation	Required	Y			Prereq	Construction Activity Pollution Prevention	Required
Y			Prereq	Floodplain Avoidance	Required	5			Credit	Certified Green Buildings	5
5	5		Credit	Preferred Locations	10	2			Credit	Optimize Building Energy Performance	2
2			Credit	Brownfield Remediation	2	1			Credit	Indoor Water Use Reduction	1
3	4		Credit	Access to Quality Transit	7	1	1		Credit	Outdoor Water Use Reduction	2
	2		Credit	Bicycle Facilities	2			1	Credit	Building Reuse	1
3			Credit	Housing and Jobs Proximity	3			2	Credit	Historic Resource Preservation and Adaptive Reuse	2
1			Credit	Steep Slope Protection	1			1	Credit	Minimized Site Disturbance	1
1			Credit	Site Design for Habitat or Wetland and Water Body Conservation	1	2	2		Credit	Rainwater Management	4
1	1		Credit	Restoration of Habitat or Wetlands and Water Bodies	1	1			Credit	Heat Island Reduction	1
1			Credit	Long-Term Conservation Management of Habitat or Wetlands and Water Bodies	1	1			Credit	Solar Orientation	1
						2	1		Credit	Renewable Energy Production	3
16	23	0	Neighborhood Pattern & Design		41			2	Credit	District Heating and Cooling	2
Y			Prereq	Walkable Streets	Required			1	Credit	Infrastructure Energy Efficiency	1
Y			Prereq	Compact Development	Required			2	Credit	Wastewater Management	2
Y			Prereq	Connected and Open Community	Required			1	Credit	Recycled and Reused Infrastructure	1
4	5		Credit	Walkable Streets	9			1	Credit	Solid Waste Management	1
3	3		Credit	Compact Development	6	1			Credit	Light Pollution Reduction	1
2	2		Credit	Mixed-Use Neighborhoods	4						
7			Credit	Housing Types and Affordability	7	1	5	0	Innovation & Design Process		6
1			Credit	Reduced Parking Footprint	1			5	Credit	Innovation	5
1	1		Credit	Connected and Open Community	2			1	Credit	LEED® Accredited Professional	1
1			Credit	Transit Facilities	1						
2			Credit	Transportation Demand Management	2	3	1	0	Regional Priority Credits		4
1			Credit	Access to Civic & Public Space	1	1			Credit	Regional Priority Credit: Rainwater Mgmt (2 pt threshold)	1
1			Credit	Access to Recreation Facilities	1	1			Credit	Regional Priority Credit: Connected and Open Community (1 pt threshold)	1
1			Credit	Visitability and Universal Design	1	1			Credit	Regional Priority Credit: Brownfield Remediation (1 pt threshold)	1
1			Credit	Community Outreach and Involvement	2	1			Credit	Regional Priority Credit: Housing and Jobs Proximity (2 pt threshold)	1
1			Credit	Local Food Production	1						
1			Credit	Tree-Lined and Shaded Streetscapes	2						
1			Credit	Neighborhood Schools	1						
47	56	5	PROJECT TOTALS (Certification estimates)		110						

Certified: 40-49 points, Silver: 50-59 points, Gold: 60-79 points, Platinum: 80+ points

LEED Building Design + Construction (BD+C) will also track the certification progress for each block DSUP. LEED certification will be the project's compliance pathway with the Alexandria Green Building Policy (GBP). All required GBP points will be noted on each building or block's LEED BD+C scorecard to be developed with each building or Block's DSUP. LEED typologies for each building or block will be developed based on its use, (typically New Construction for residential and Core & Shell for commercial). A preliminary LEED BD+C New Construction scorecard is shown below, outlining the GBP required points in the credit name in bold with the minimum points required.



LEED v4 for BD+C: New Construction and Major Renovation

Preliminary Checklist

Project Name: Potomac River Generating Station Blocks
Date: January 2023



Y ? N
Credit Integrative Process 1

0	0	0	0	Location and Transportation	16
				Credit LEED for Neighborhood Development Location	16
				Credit Sensitive Land Protection - not applicable with LEED for ND credit	1
				Credit High Priority Site - not applicable with LEED for ND credit	2
				Credit Density and Diverse Uses - not applicable with LEED for ND credit	5
				Credit Access to Quality Transit - not applicable with LEED for ND credit	5
				Credit Bicycle Facilities - not applicable with LEED for ND credit	1
				Credit Reduced Parking Footprint - not applicable with LEED for ND credit	1
				Credit Green Vehicles - not applicable with LEED for ND credit	1

0	0	0	0	Materials and Resources	13
				Prereq Storage and Collection of Recyclables	Required
				Prereq Construction and Demolition Waste Management Planning	Required
				Credit Building Life-Cycle Impact Reduction	5
				Credit Building Product Disclosure and Optimization - Environmental Product Declarations	2
				Credit Building Product Disclosure and Optimization - Sourcing of Raw Materials	2
				Credit Building Product Disclosure and Optimization - Material Ingredients	2
				Credit Construction and Demolition Waste Management(CDD Condition #152)	2

0	0	0	0	Sustainable Sites	10
				Prereq Construction Activity Pollution Prevention	Required
				Credit Site Assessment	1
				Credit Site Development - Protect or Restore Habitat	2
				Credit Open Space	1
				Credit Rainwater Management	3
				Credit Heat Island Reduction	2
				Credit Light Pollution Reduction	1

0	0	0	0	Indoor Environmental Quality	16
				Prereq Minimum Indoor Air Quality Performance	Required
				Prereq Environmental Tobacco Smoke Control	Required
				Credit Enhanced Indoor Air Quality Strategies	2
				Credit Low-Emitting Materials (GBP: min 1 pt)	3
				Credit Construction Indoor Air Quality Management Plan	1
				Credit Indoor Air Quality Assessment	2
				Credit Thermal Comfort (GBP: 1 pt)	1
				Credit Interior Lighting	2
				Credit Daylight	3
				Credit Quality Views	1
				Credit Acoustic Performance	1

0	0	0	0	Water Efficiency	11
				Prereq Outdoor Water Use Reduction	Required
				Prereq Indoor Water Use Reduction	Required
				Prereq Building-Level Water Metering	Required
				Credit Outdoor Water Use Reduction (GBP: min 1 pt)	2
				Credit Indoor Water Use Reduction (GBP: min 4 pts)	6
				Credit Cooling Tower Water Use	2
				Credit Water Metering	1

0	0	0	0	Innovation	6
				Credit Innovation	5
				Credit LEED Accredited Professional	1

0	0	0	0	Energy and Atmosphere	33
				Prereq Fundamental Commissioning and Verification	Required
				Prereq Minimum Energy Performance	Required
				Prereq Building-Level Energy Metering	Required
				Prereq Fundamental Refrigerant Management	Required
				Credit Enhanced Commissioning	6
				Credit Optimize Energy Performance (GBP: min 5 pts)	18
				Credit Advanced Energy Metering (GBP: 1 pt)	1
				Credit Demand Response	2
				Credit Renewable Energy Production (GBP: min 2 pts)	3
				Credit Enhanced Refrigerant Management	1
				Credit Green Power and Carbon Offsets	2

0	0	0	0	Regional Priority	4
				Credit Regional Priority: Rainwater Mgmt (3 pt threshold)	1
				Credit Regional Priority: Optimize Energy (10 pt threshold)	1
				Credit Regional Priority: Green Vehicles (1 pt threshold)	1
				Credit Regional Priority: Reduced Pkg Footprint (1 pt threshold)	1

0	0	0	0	TOTALS	Possible Points: 110
Certified: 40 to 49 points, Silver: 50 to 59 points, Gold: 60 to 79 points, Platinum: 80 to 110					

V. Clean Energy, RECs & Carbon Offset Pricing

For Virginia, Dominion Energy offers utility customers four programs where they can obtain their own clean energy. These options are only available to the account holder with the electric utility. As of February 2, 2023, the table below summarizes the cost of clean energy options through the utility⁸.

Dominion Energy Program	Generation Mix	Location of Generation	Cost (\$/MWh)
REC Select	Wind	Oklahoma, Nebraska & Kansas	\$3
100% Renewable Energy	Biomass, Hydro, Solar PV	Virginia, North Carolina	\$4
Green Power (Green-e certified)	Solar, Wind	Virginia and surrounding regions	\$12
Community Solar	Solar	Virginia	\$20

In the United States, the cost of RECs have been volatile in response to rising demand from more entities committing to sustainable practices. In the last three years, the average cost of RECs has tripled from \$1.00 to \$3.00, with a spike peaking at \$7.00 in August 2021. Large bundles of RECs can be contracted annually or for multiple years. Pricing breakdown typically factors in energy generation location, third party verification/certification and the time at which the project goes online. The table below outlines the varying costs with these factors as of January 23, 2023.

REC Type	Generation Mix	Location of Generation	Cost (\$/MWh)
Not Certified – any US location	Hydro, Wind	National	\$4
Certified – any US location	Wind	National	\$6.50
Certified – PJM Region	Solar, Wind	Virginia and Pennsylvania	\$22

PPAs are another off-site clean energy procurement option but require finalized details for energy brokers to start lining up contracting options. As block designs further progress, details from energy modeling will be tracked for this option.

Carbon offsets in the US are currently available starting around \$3/ton, but do not come with any third party verification to ensure that they are not double counted. Most options that are available from reputable vendors with some level of verification range from \$10-30/ton. These prices are subject to increase if there are future regulatory carbon trading programs established which would greatly increase the costs.

⁸ [Dominion Energy Renewable Energy Programs](#)

VI. PRGS District Energy Feasibility Study

Hilco Redevelopment Partners (HRP) Potomac River Generating Station Site

Alexandria, VA

District Energy Feasibility Analysis

February 14, 2023

Executive Summary

Introduction & Background

This report summarizes the district energy and microgrid feasibility studies performed for the redevelopment of the former Potomac River Generating Station (PRGS) site located in Alexandria, VA. “District energy systems” combine energy loads from multiple buildings to create economies of scale that help reduce energy costs and enable the use of high-efficiency equipment, reducing energy demand. A “microgrid” is a small, local source of electricity that can function independently of the centralized national grid (e.g., on-site solar panels coupled with battery back up).

The purpose of this study is to analyze the feasibility, limitations and possible benefits of incorporating district thermal energy and microgrid systems in lieu of standalone building systems in the project. District energy systems for the site are referenced in the prior Old Town North Small Area Plan and the associated Eco-District Study. The proposed PRGS development consists of up to 2.5 million square feet of residential and commercial uses (office, retail and restaurant), with residential anticipated to be the primary use at approximately 80% of the total square footage.

District energy and combined heat and power (CHP) systems became popular a decade ago when the energy performance and cost efficiency of natural gas systems were considered desirable. However, since CHP systems rely on fossil fuel use, they have fallen out of favor in recent years. **This study considers only electric district energy and microgrid systems to minimize or eliminate fossil fuel emissions generated at the site.** The analysis considers the energy produced, related emissions, and economic impact of different district thermal and microgrid configurations. Physical site limitations, resilience considerations, construction and operational costs, and other factors are all considered as part of the analysis.

District Thermal Analysis Method & Results

In any carbon reduction analysis, the primary on-site strategy is to **use less energy**. Therefore, the approach in the district thermal analysis was to first improve the energy efficiency of the individual building designs using enhanced envelope and optimized mechanical (heating and cooling) systems. The use of an enhanced building envelope positively contributes to building performance by reducing heating and cooling energy consumption but reduces opportunities to recapture waste heat via a district system.

To establish a baseline from which district energy systems are measured, two standalone building scenarios were considered:

- ‘Standalone Buildings – VRF’ scenario utilizes variable refrigerant flow (VRF) air source heat pump systems
- ‘Standalone Buildings – CW’ scenario utilizes water source heat pump systems via a condenser water system

Both standalone building scenarios include electrification of heating and cooling systems and incorporate strategies to maximize in-building energy recovery.

Four district energy scenarios were studied utilizing the following technologies independently and in combination:

- ambient loop
- ground source heat pump
- sewer heat recovery

All the district energy scenarios add complexity and cost that are not offset by the modest performance improvements achieved. The district energy scenarios provide only a modest reduction in site energy use intensity (EUI) and operational carbon emissions as compared to both standalone buildings scenarios. **This is because the individual building**

designs are already highly energy efficient and utilize electrified heating and cooling systems. As a result, the district energy options generate negative net present values. **Additionally, the site-wide infrastructure required for district systems would increase the first impacts of embodied carbon** (greenhouse gas emissions resulting from construction).

The study found that **focusing on making individual building designs as efficient as possible and including electrified (heat pump) systems for heating and cooling has more beneficial energy, emissions, and economic impact than constructing a district energy system.**

Microgrid Analysis Method & Results

Microgrids work best on sites where the distributed energy sources (on-site solar panels and batteries) can help the site “island” in case of an electrical grid interruption. The 3% of photovoltaic solar panel (PV) electricity generated on-site would not allow the PRGS site to operate without connection to the grid due to the size of the development and the size limitations of an on-site PV microgrid.

In addition to “islanding,” microgrids can reduce demand on the national grid by generating on-site energy to reduce peak loads. The on-site PV system is the primary microgrid asset considered in this study because solar microgrids produce clean energy, can be applied at any scale and have future expansion potential. Additionally, Battery Energy Storage Systems (BESS) allow the supply of backup power by using a group of batteries to store electrical energy. These were examined in conjunction with the PV system to reduce peak electrical loads on site.

A BESS would have little impact across the site and has the capability to backup only 3% of the development's peak loads with its kW rating. This type of system would be more beneficial for resilience considerations in projects where there are critical electrical systems that require a 24/7 emergency power supply for reliability, such as in hospital or healthcare facilities.

Table of Contents

Executive Summary

Page 2

Part A. District Thermal Feasibility

A.1. District Thermal Introduction	Page 4
A.2. Standalone Building Scenarios	Page 7
A.3. District Energy Screening Analysis	Page 11
A.4. District Energy Technologies	Page 14
A.5. District Energy Scenario 1	Page 18
A.6. District Energy Scenario 2	Page 21
A.7. District Energy Scenario 3	Page 27
A.8. District Energy Scenario 4	Page 31
A.9. District Energy Results and Conclusions	Page 35
A.10. Other District Energy Technologies Assessed	Page 41

Part B. Microgrid Feasibility

B.1. District Energy Microgrid Feasibility	Page 46
B.2. PV + BESS Overall Energy Contribution	Page 47
B.3. PV Analysis and Rooftop Considerations	Page 48
B.4. Microgrid Feasibility Conclusions	Page 50

A.1. District Thermal Introduction

A.1.1 DISTRICT THERMAL INTRODUCTION DATA COLLECTION AND SITE INVESTIGATION

Overview of District Energy Study

Goals of Study

Complete a **Feasibility Assessment for a District Energy System (DES)** involving:

- Target reduced energy consumption and GHG emissions
- Target cost reductions for end users
- Consider energy supply resilience
- Consider pre-operational carbon emissions (i.e. embodied carbon) associated with DES

Study Process

- Develop energy demand profiles for the buildings (heating, cooling and electricity) based upon specific building occupancy types (residential and commercial) utilizing an enhanced building envelope (i.e., highly energy efficient building envelopes).
- Analyze heat recovery potential between concurrent building heating and cooling demands.
- Assess energy footprint of Basis of Design / Baseline Systems:
 - The baseline building system in this study is referred to as **Standalone Buildings - VRF**. However, VRF systems are not able to fully benefit from the energy recovery available from district energy technologies.
 - Therefore, for the purposes of accessing the feasibility of a district energy system at PRGS, we added a **Standalone Buildings - Condenser Water (CW)** scenario, which will capture energy recovery available from district energy technologies. We then layered the four district system scenarios on top of this system.
 - As shall be discussed further, the **Standalone Buildings - CW** uses internal hydronic condenser water (CW) building systems utilizing heat pumps. It has a very similar energy footprint to the baseline **Standalone Buildings - VRF** scenario, which utilizes Variable Refrigerant Flow (VRF) with heat recovery equipment to provide cooling and heating.
- A total of 4 DES configurations have been analyzed. The first starts with an ambient loop (ambient temperature hydronic piping loop) connected to all buildings to allow for both heat recovery between buildings and the connection of high-efficiency thermal technologies.
- Then, additional high-efficiency heating/cooling technologies have been layered on to the ambient loop system in various combinations. These technologies include a ground source heat pump (GSHP) borehole system and a sewage heat recovery (SHR) system.

A.1.2 DISTRICT THERMAL INTRODUCTION UTILITY LOAD PROFILES

Modeling Approach – Hourly Load Profiles

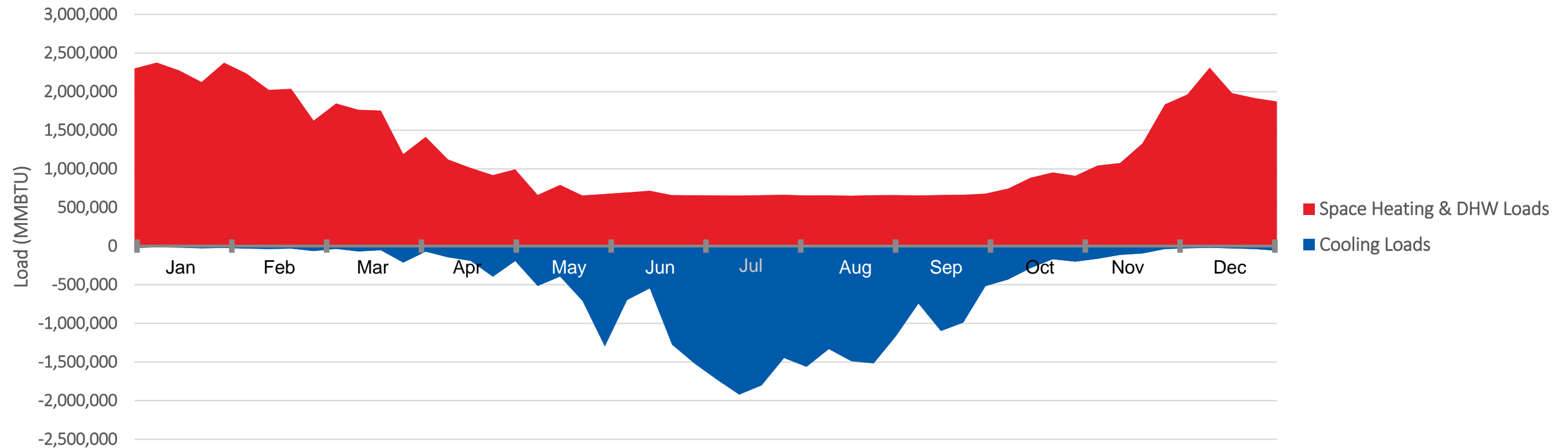

- To evaluate the feasibility of a District Thermal Energy System, annual hourly (8,760) load profiles (for heating, cooling and electricity) were generated for the buildings in the PRGS development.
- The graph above illustrates the annual thermal load profiles for the complete project site for both heating and cooling
- The **red** portion represents the quantities of heat that the buildings need supplied for warmth and domestic hot water production (heating). The **blue** portion represents the quantity of cooling needed to remove heat from the buildings (typically in the summer months). Heat recovery is not accounted for in these profiles.
- Heating and cooling load profiles are based on prototype building energy models for an ASHRAE 4A climate zone and the Alexandria ASHRAE 90.1-2016 energy code performance requirements. See the appendices for additional details.

A.2. Standalone Building Scenarios

A.2.1 DISTRICT THERMAL ANALYSIS Market (based upon IECC 2018/ASHRAE 90.1-2016)

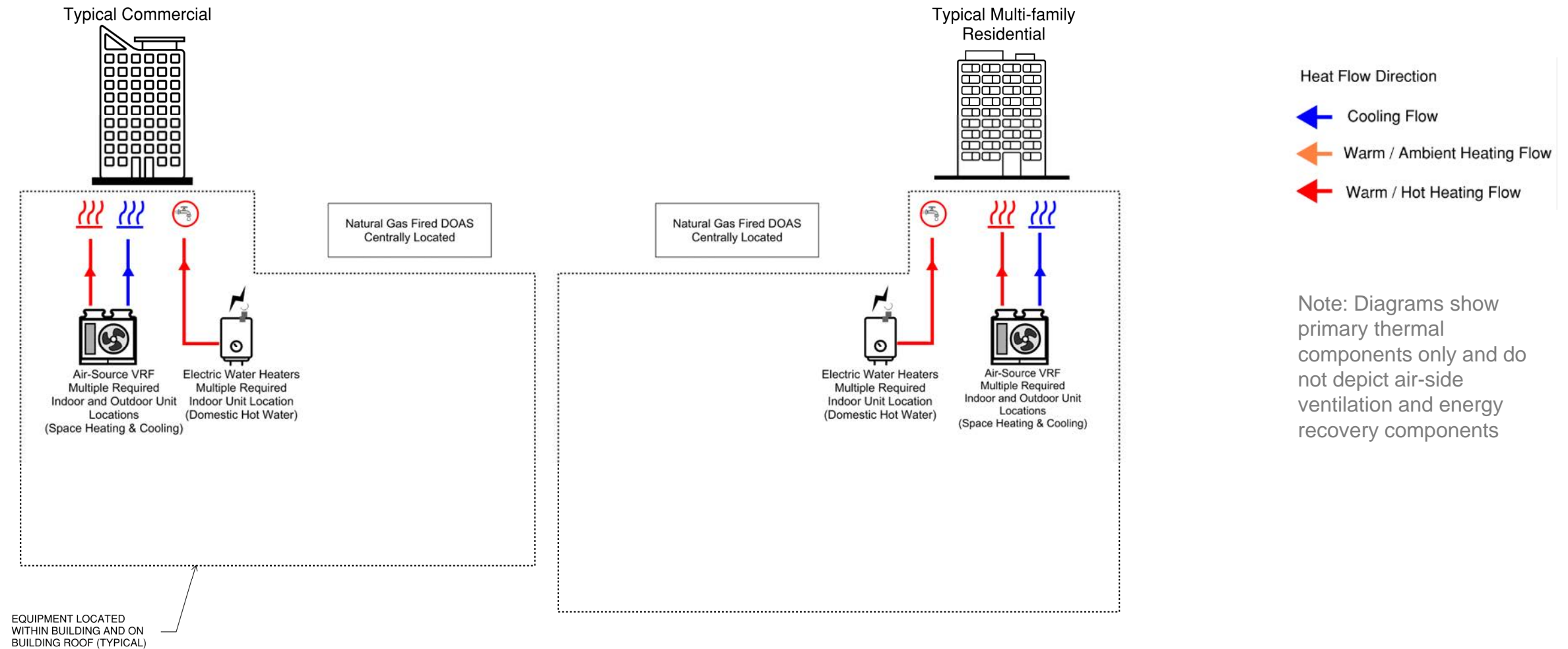

Commercial and Multi-family Residential Typologies (using code compliant envelopes)

The **Market** system illustrates a base case for the purposes of comparing against the following 2 standalone scenarios as well as against the district systems evaluated (District Energy Scenarios 1-4). In the Market system for this analysis, both the commercial and multi-family residential buildings are all-electric and do not share any mechanical equipment. Heating and cooling loads within the buildings are served by multiple air-source VRF systems (which are dedicated to each tenant or housing unit). Domestic hot water is generated by multiple electric water heaters (which are also dedicated to each tenant or housing unit).

A.2.2 DISTRICT THERMAL ANALYSIS

Standalone Buildings - VRF system

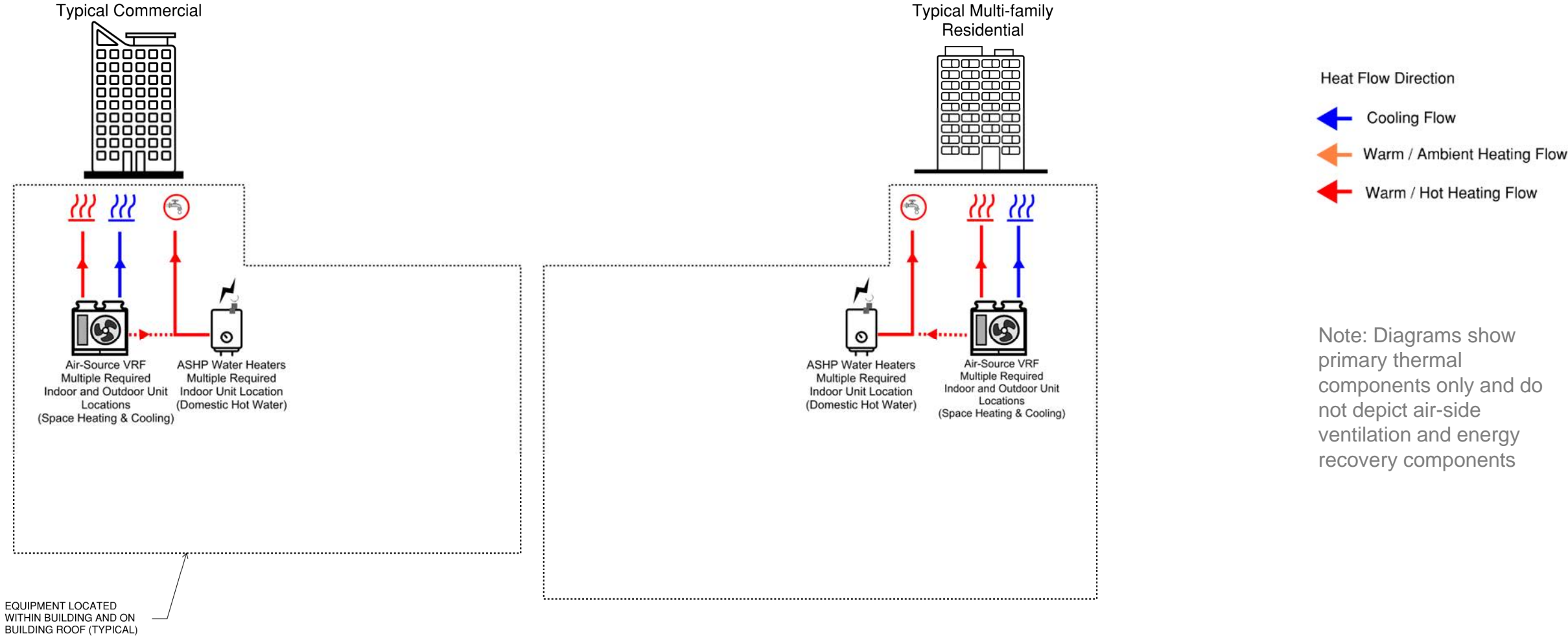

Commercial and Multi-family Residential Typologies (utilizing enhanced building envelopes)

The **Standalone Buildings - VRF** system for both commercial and multi-family residential buildings utilizes Variable Refrigerant Flow (VRF) with heat recovery equipment to provide cooling and heating. Commercial and residential buildings do not share any heating or cooling equipment in this system (i.e., they are standalone). These systems are air source heat pumps (extract or reject heat from ambient outdoor air) and they distribute thermal energy via refrigerant throughout a building. Multiple independent systems serve an entire building. These systems are energy efficient and can utilize recovered waste heat by capturing the excess heat and transferring it to space heating or domestic hot water heating (DHW). However, since each VRF system is independent, heat cannot be shared from one building to another and VRF's are therefore not compatible with a district energy system.

In this scenario, DHW in both the commercial and multi-family residential typologies can utilize any recovered waste heat and be supplemented by a heat pump water heater.

A.2.3 DISTRICT THERMAL ANALYSIS

Standalone Buildings – CW system

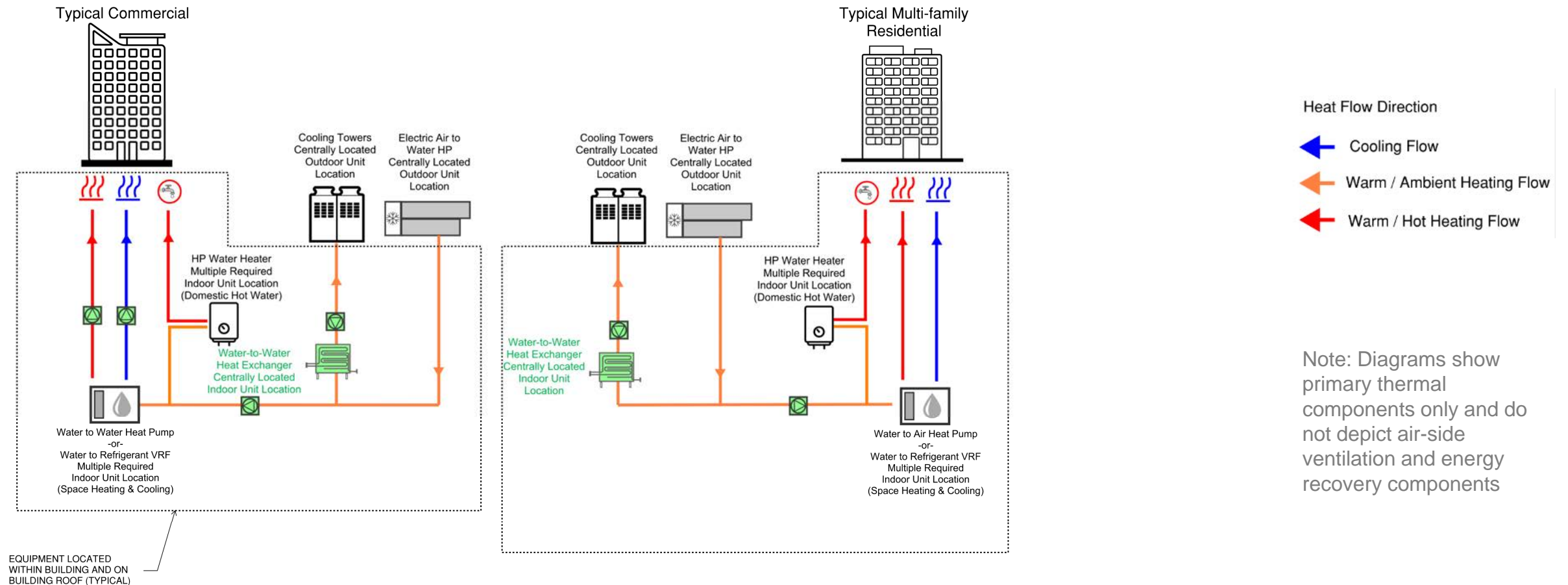

Commercial and Multi-family Residential Typologies (utilizing enhanced building envelope)

The **Standalone Buildings - Condenser Water (CW)** system for both commercial and multi-family residential typologies utilizes water source heat pump equipment (or water-to-refrigerant VRF) to provide cooling and heating. Multiple heat pumps within each building move heat to/from a shared hydronic CW loop that serves the full extent of each building. In commercial space, thermal conditioning is provided by a water-to-water heat pump and the conditioned water (heated or cooled) is circulated to terminal HVAC equipment in the occupied space. In multi-family residential space, thermal conditioning is provided by a water-to-air heat pump and the conditioned air (heated or cooled) is circulated to each occupied space. Excess heat from the condenser water loop is rejected to the outside via a cooling tower. Available heat in the condenser water loop is supplemented by an air-to-water heat pump, when required. CW systems can utilize recovered waste heat internally within each building by moving the heat from a space requiring cooling to a useful heating purpose (i.e., space heating or DHW heating). Since each heat pump system within the building is interconnected via the condenser water loop, heat can be shared from one system to another and therefore, CW systems are compatible with a district energy approach.

DHW in the both the commercial and multi-family residential typologies can also be interconnected to the condenser water loop to maximize recovered waste heat.

A.3. Screening Analysis

A.3. DISTRICT THERMAL ANALYSIS SCREENING ANALYSIS

District System Technologies

Several technologies were analyzed to determine their ability to improve overall energy, emissions, and economic performance.

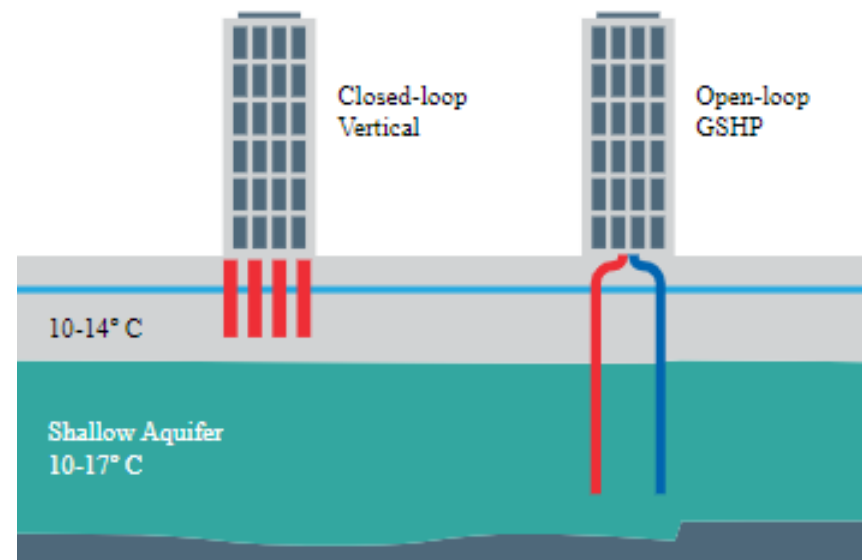

District thermal energy exchange (Ambient Loop):

Varying configurations of thermal energy exchange between buildings to allow waste heat from commercial buildings to be recovered and used for residential buildings' simultaneous domestic hot water heating demands.

Ground source heat pump (GSHP):

Coupling building closed hydronic loops to a network of boreholes to reject or extract heat from the ground, which is assumed to remain at relatively consistent year-round temperatures.

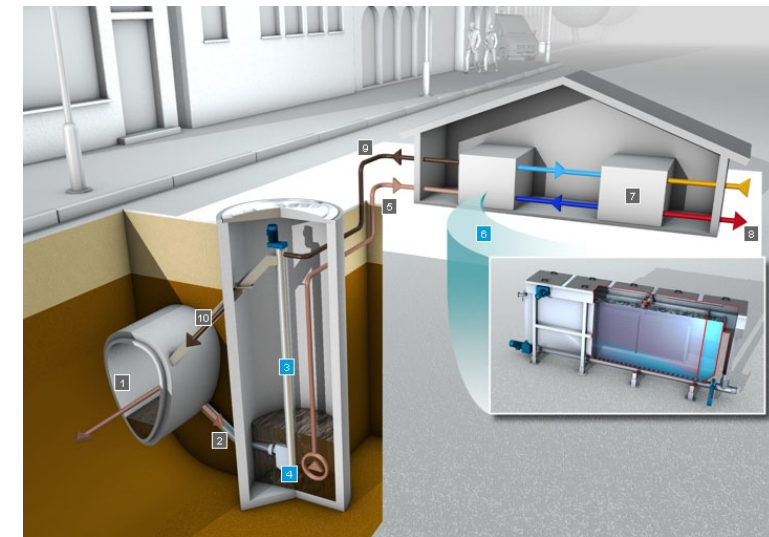

Image courtesy of Huber Technology

Sewer Heat Recovery (SHR):

Thermal energy from wastewater is captured via water-source heat pumps and used to add heat to the Ambient Loop.

A.3. DISTRICT THERMAL ANALYSIS SCREENING ANALYSIS

Scenarios considered

Three stand-alone building systems were considered as a foundation of the district energy analysis:

- **Market (based upon IECC 2018/ASHRAE 90.1-2016):** This is included only to provide a reference point for the comparison of the additional Standalone Building cases and District Energy cases; this is an all-electric building scenario.*
- **Standalone Buildings - VRF:** building by building, multiple VRF systems for each building
- **Standalone Buildings - CW:** building by building, dedicated condenser water system for each building

Multiple district energy scenarios were considered to evaluate the benefits of implementing the technologies reference on the preceding page in isolation and in combination. The various scenarios are:

- **District Energy Scenarios**
 1. **CW + Ambient Loop** (Built off the 'Standalone Buildings – CW system', injecting energy from heat rejection to be used for heating/DHW in any buildings)
 2. **CW + Ambient Loop + GSHP**
 3. **CW + Ambient Loop + Sewer Heat Recovery**
 4. **CW + Ambient Loop + GSHP + Sewer Heat Recovery**

*While it is still common to see gas in “Market” buildings, this study and the electrification of the proposed Market scenario aligns with CDD conditions for all electric building systems.

A.4. District Energy Technologies

A.4.1 DISTRICT THERMAL ANALYSIS

Total Building Electricity Use

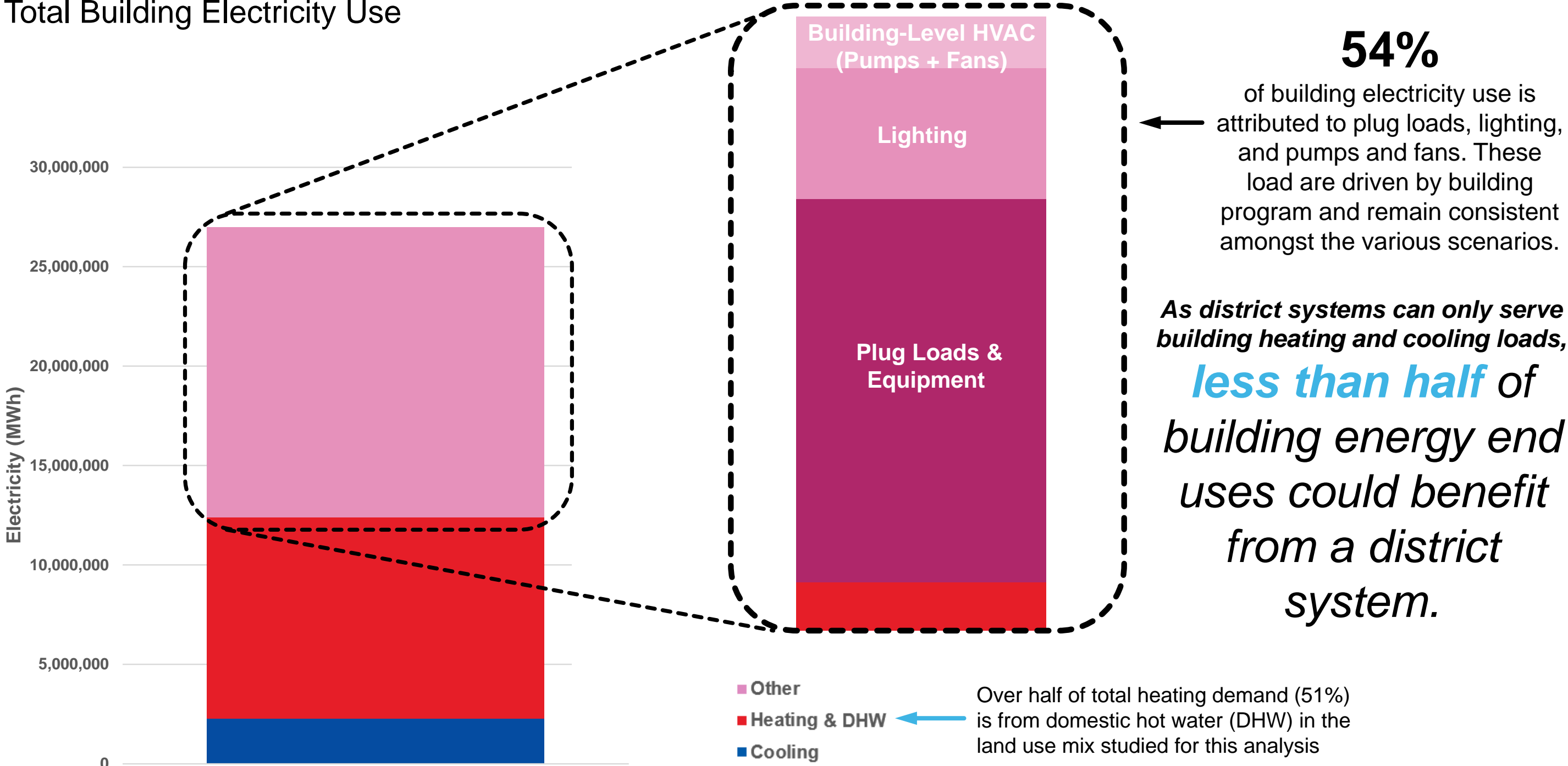

A.4.1 DISTRICT THERMAL ANALYSIS

Aggregate Annual Thermal Load Profile

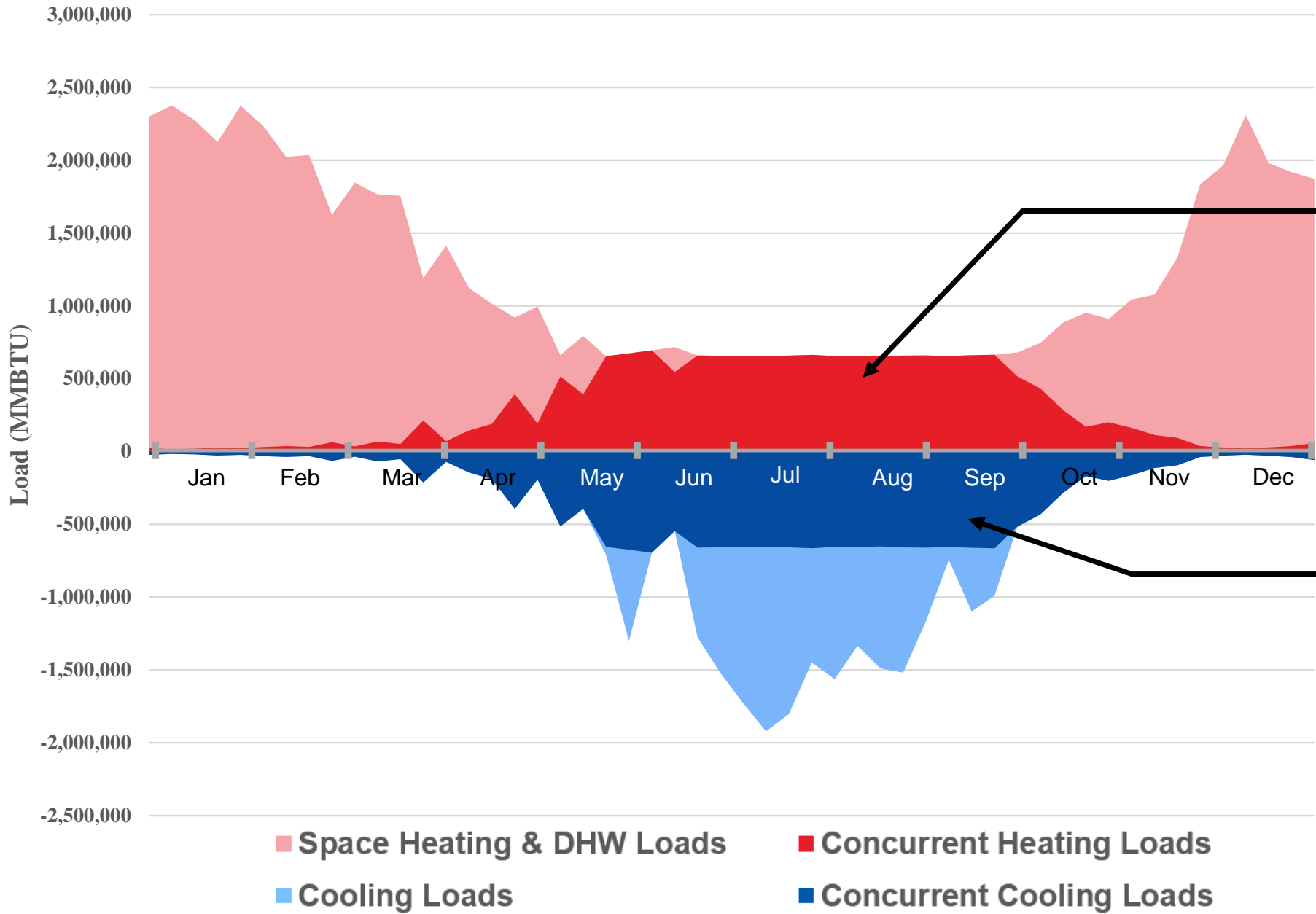

When buildings are rejecting heat from their cooling systems and there are simultaneous heating demands in the buildings, opportunity exists to recover that waste heat to satisfy the heating demands and save on imported energy from the grid.

25% of heating loads concurrent with simultaneous cooling

These concurrent loads could hypothetically be served by in-building heat recovery systems or by a district ambient loop in order to reduce energy demand.

60% of cooling loads concurrent with simultaneous heating

A.4.2. DISTRICT THERMAL ANALYSIS

Heat Recovery Impact Assessment

When buildings become more efficient recovering their own waste heat, there is less to share with the district.

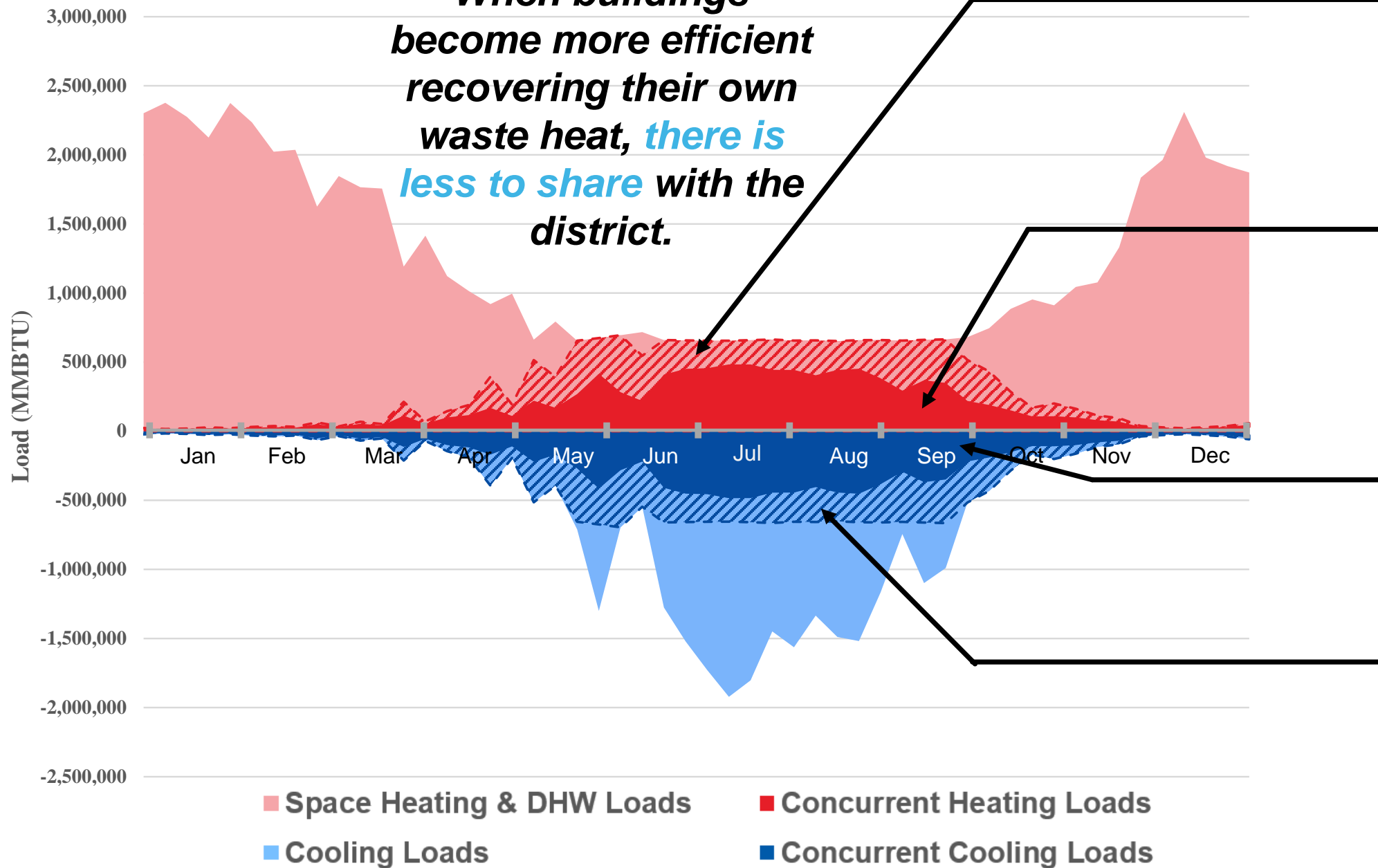

11% of heating loads
concurrent loads satisfied within a building

These concurrent loads could be satisfied by heat recovery within the Standalone Buildings - CW building systems.

14% of heating loads
concurrent loads satisfied by district systems

These concurrent loads could be satisfied by heat recovery between buildings by a district ambient loop (reducing the required cooling/heating energy).

35% of cooling loads
concurrent loads satisfied by district systems

These concurrent loads could be satisfied by heat recovery between buildings via a district loop

25% of cooling loads
concurrent loads satisfied within a building

These concurrent cooling loads could be recovered within the 'Standalone Buildings - CW' buildings using via internal building condenser water loops.

A.5. District Energy Scenario 1

CW + Ambient Loop

A.5.1 DISTRICT THERMAL ANALYSIS

District Energy Scenario 1 System

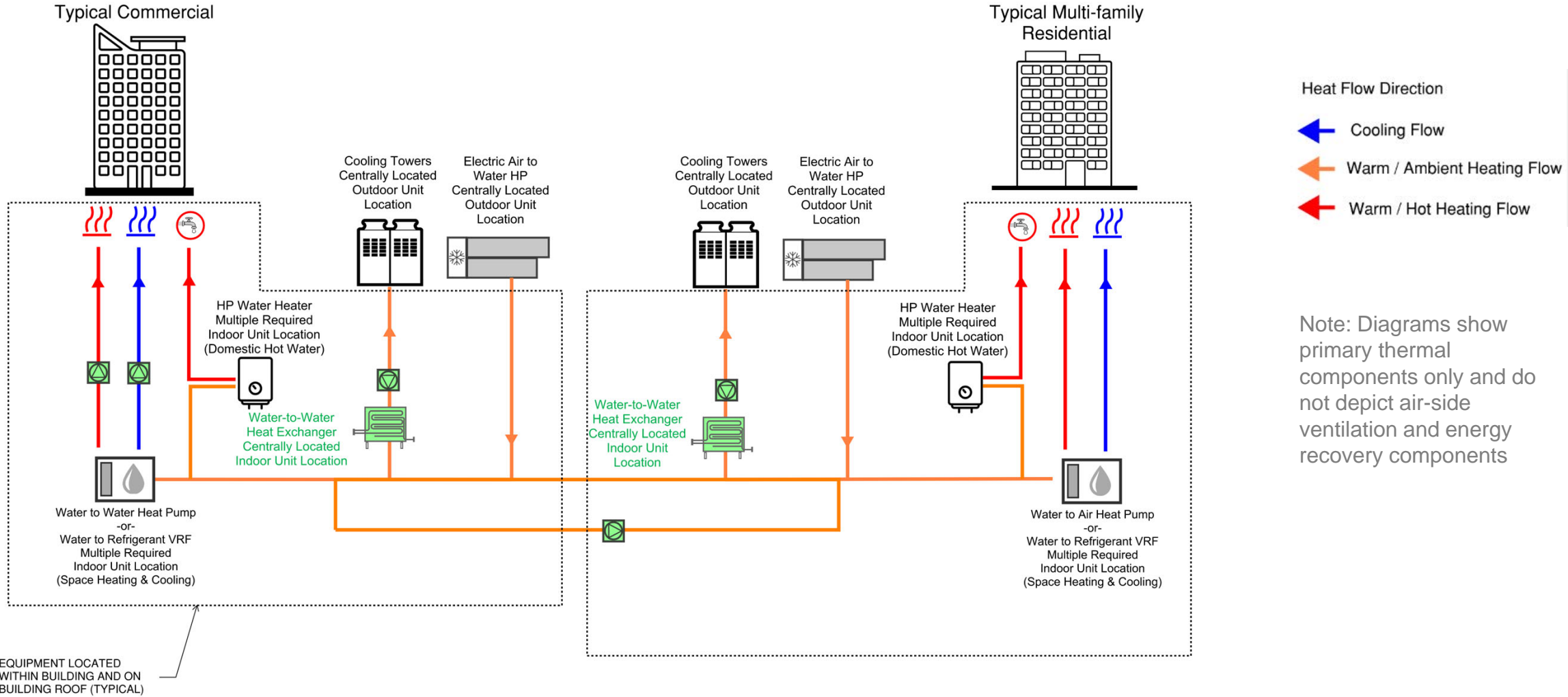

Commercial and Multi-family Residential Typologies

The **District Energy Scenario 1** system is similar to the **Standalone Buildings - CW** system except that the condenser water loop is interconnected to all buildings throughout the site to create the 'Ambient Loop'. Recovered heat is utilized within each individual building first, then any excess heat will be circulated to other buildings to maximize heat recovery. Excess heat from the ambient loop is rejected to the outside via cooling towers (shared amongst all buildings). Available heat in the ambient water loop will be supplemented by air to water heat pumps (shared amongst all buildings) when required. **The energy required to move the recovered heat from one building to another via the ambient loop slightly diminishes the overall energy benefit.**

A.5.2 DISTRICT THERMAL ANALYSIS

District Energy Scenario 1 Potential

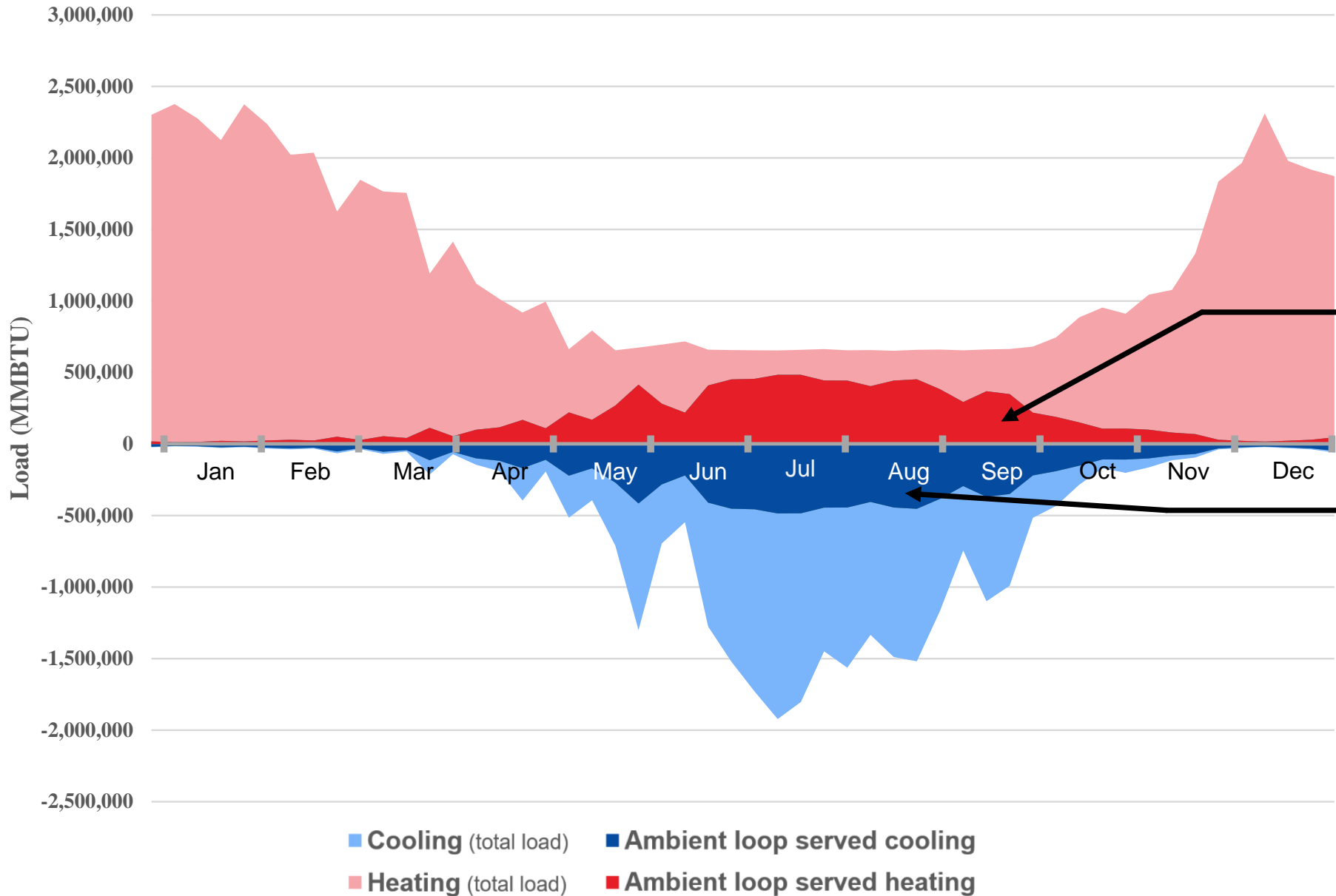

Ambient loop: 14%
of heating loads served by the ambient loop via a district energy system

Ambient loop: 35%
of cooling loads served by the ambient loop via a district energy system

A.6. District Energy Scenario 2

CW + Ambient Loop + Ground Source Heat Pump

A.6.1 DISTRICT THERMAL ANALYSIS

District Energy Scenario 2 System

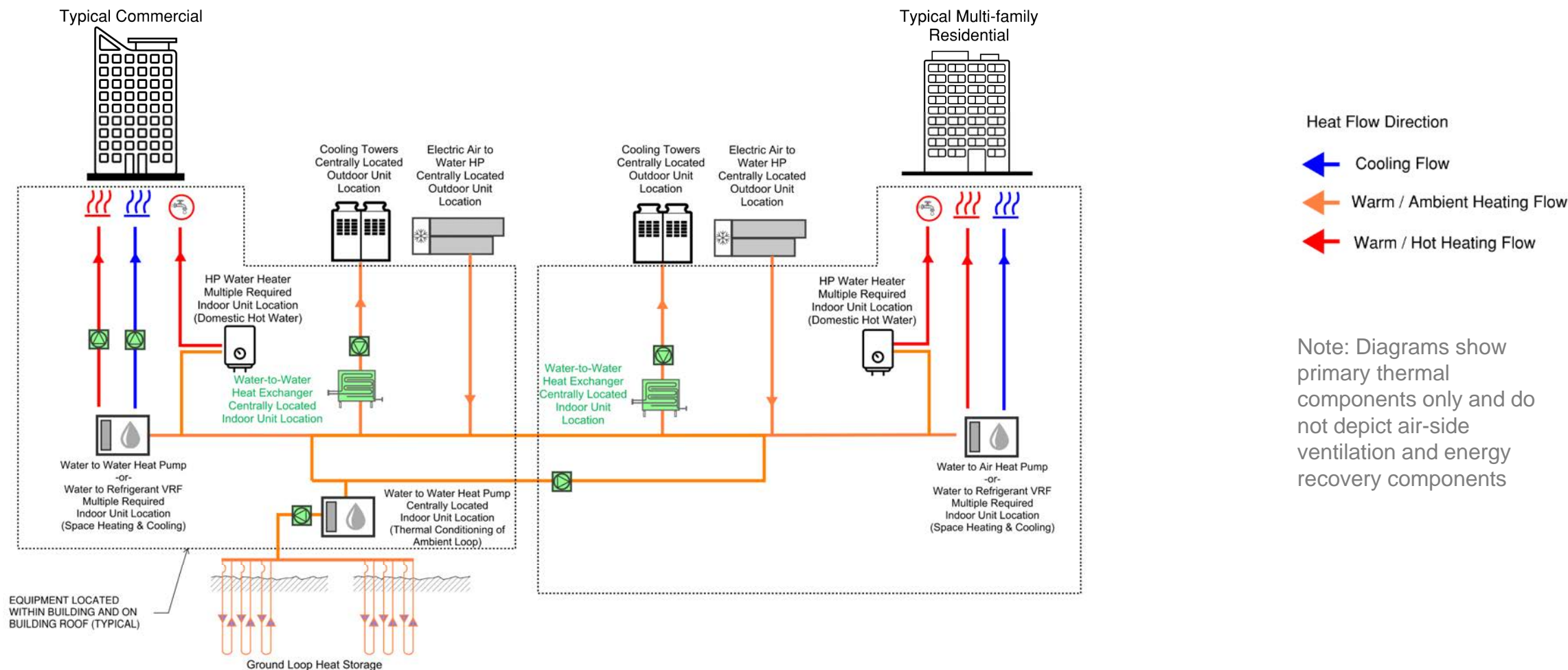

Commercial and Multi-family Residential Typologies

The **District Energy Scenario 2** system is similar to the **District Energy Scenario 1** system with the addition of a ground source heat pump (GSHP or geothermal) system to supplement the Ambient Loop. A fluid is circulated through a network of deep geothermal wells to provide another location to move heat to/from. Water-to-water heat pumps will be utilized to adjust (raise or lower) the temperature of the fluid in the ambient loop. The ground source heat pump system supplements the cooling tower and air-to-water heat pumps already included.

The relatively consistent ground temperature is beneficial during heating months when the outside air is very cold and the efficiency of an air source heat pump diminishes. **This is of greater benefit in northern climates where very cold outside air conditions occur for a higher fraction of annual hours.**

A.6.2 DISTRICT THERMAL ANALYSIS GSHP Site Constraints

A variety of site constraints impact the potential implementation of a GSHP-based district thermal energy system on the PRGS site, including:

- Conflicts with existing and future utilities under Road A and in Pepco transmission line easement
 - Geothermal wells would **interfere** with underground utility pathways
- Construction prohibited in Resource Protection Area
 - Designated by Virginia Department of Conservation and Recreation as **protected area**
- GSHPs can't be located beneath the existing pumphouse and guard house structures to remain
- Conflicts with underground parking structure
 - **Access** to boreholes would be limited for maintenance and repair
 - Phased garage development and varying potential structure depths pose implementation challenges
- Control of Pepco Substation and Norfolk Southern land
 - These areas are **not owned by HRP**

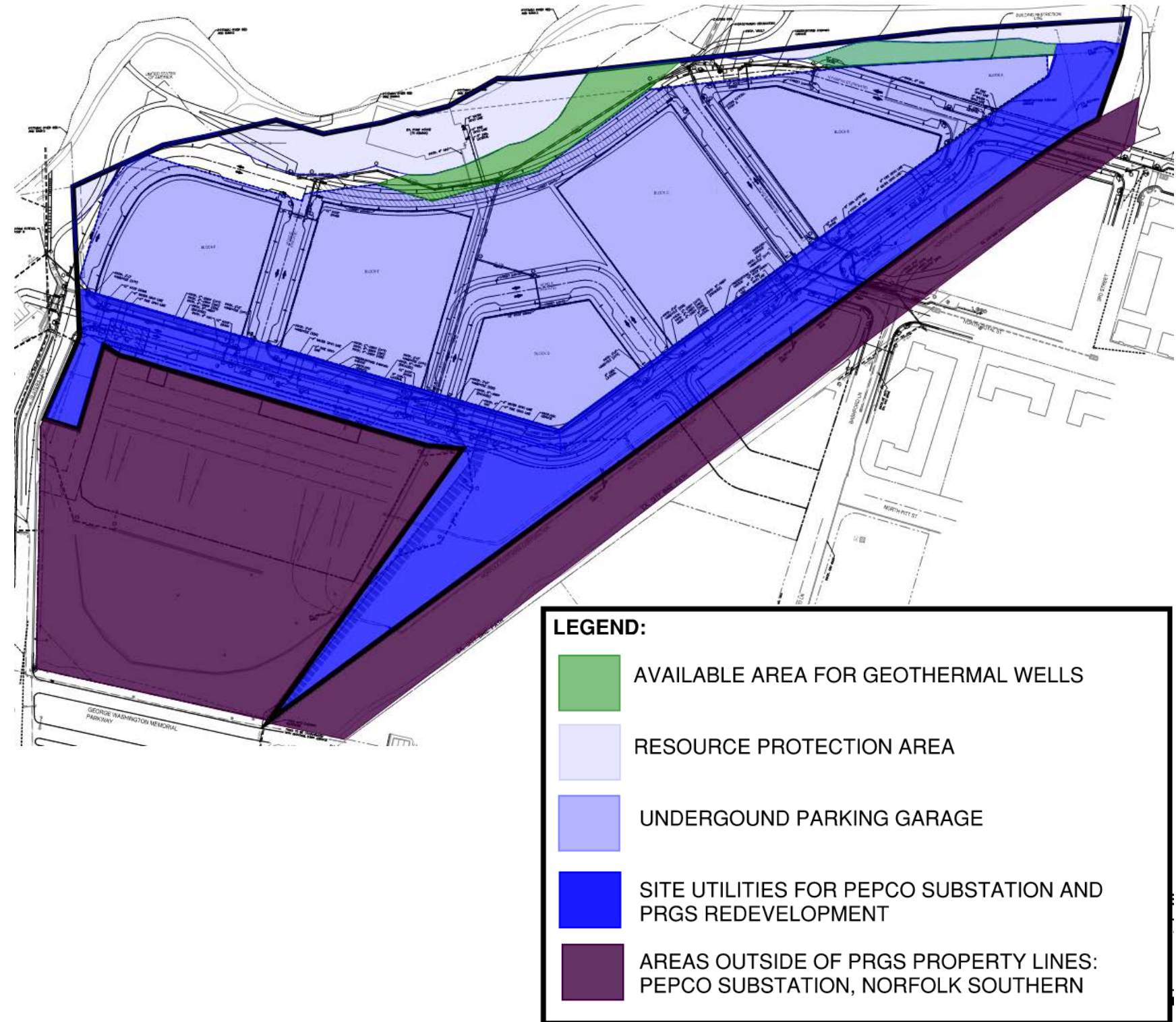

A.6.3 DISTRICT THERMAL ANALYSIS GSHP System Evaluation

Ground Source Heat Pump Well Boreholes

GSHPs exchange heat between a building and the earth. When heating is required in a building, heat is pulled from the ground; when cooling is required, heat is rejected into the ground. **GSHPs must be geo-balanced, meaning the amount of heat rejected annually must equal the amount of heat extracted annually. Unbalanced loads may alter the ground temperature over the course of numerous years which reduces system performance and creates negative environmental consequences.** Balancing of the heating load is a constraining factor.

Under 1 acre of site area is viable for the installation of geothermal wells as shown in the green area to the right. The analysis considered this green area for the purposes of a “best case GSHP scenario,” however, this is an idealized condition subject to change. Site design is ongoing and there may be conflicts with required stormwater infrastructure, which would further reduce the currently available area for geothermal wells.

Each well is assumed to require 400 ft² (20 ft x 20 ft spacing) of ground footprint to provide adequate clearance from adjacent boreholes. Using these dimensions, the site can accommodate approximately 65 wells.

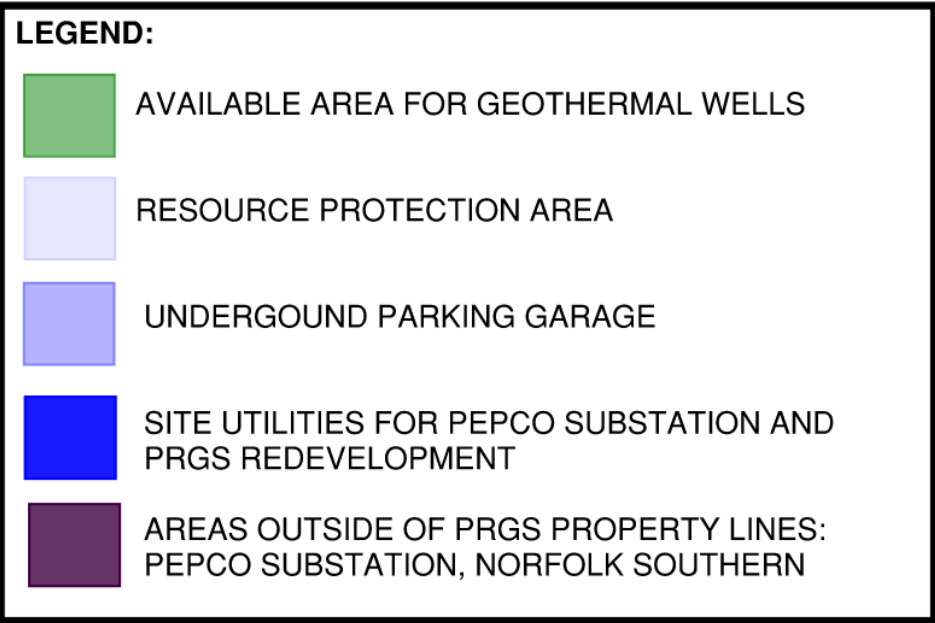
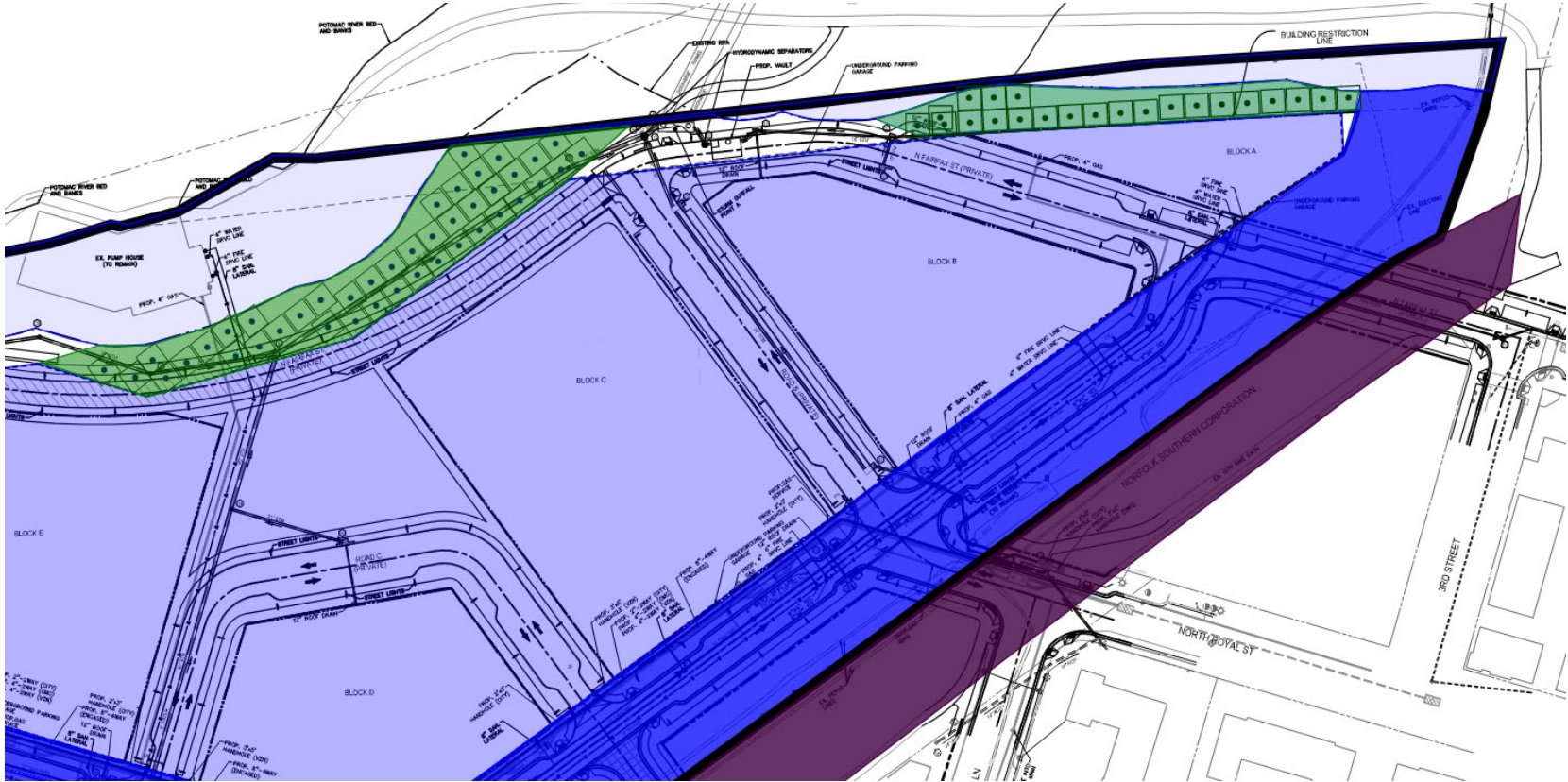

A.6.3 DISTRICT THERMAL ANALYSIS GSHP System Evaluation

GSHP System Summary Considerations for PRGS

- Under a “best case GSHP scenario,” under 1 acre of land is viable for the installation of geothermal wells
- GSHP capacity is limited by annual geo-balancing
- Heat extraction (winter heating load) must equal heat rejection (summer cooling load)
- Given the Alexandria climate and the 80% residential and 20% commercial program, the **GSHP capacity will be limited by the summer heat rejection load.**
 - A programming mix closer to 50% residential and 50% commercial would be needed to maximize the highest available energy recovery with the necessary geo-balance.
- Heat extraction occurs between December and February
 - All other months require heat rejection

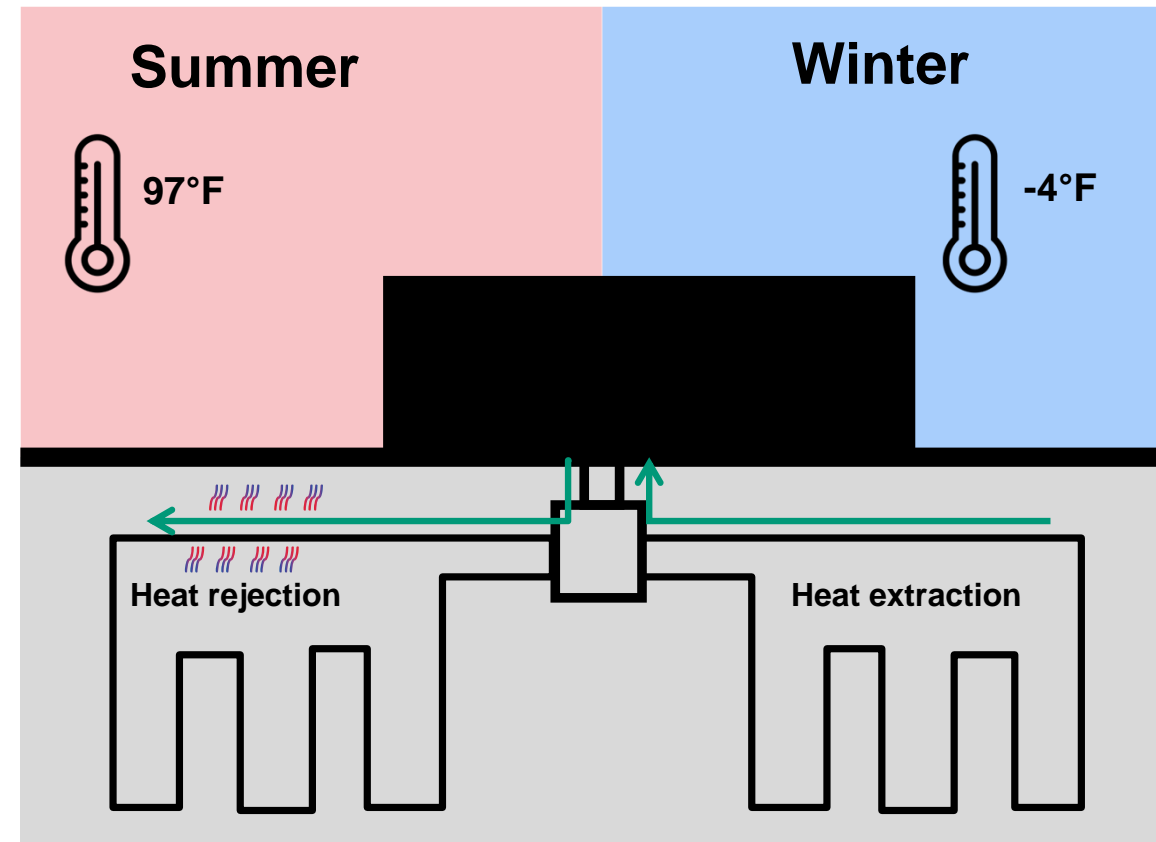

A.6.4 DISTRICT THERMAL ANALYSIS

District Energy Scenario 2 Potential

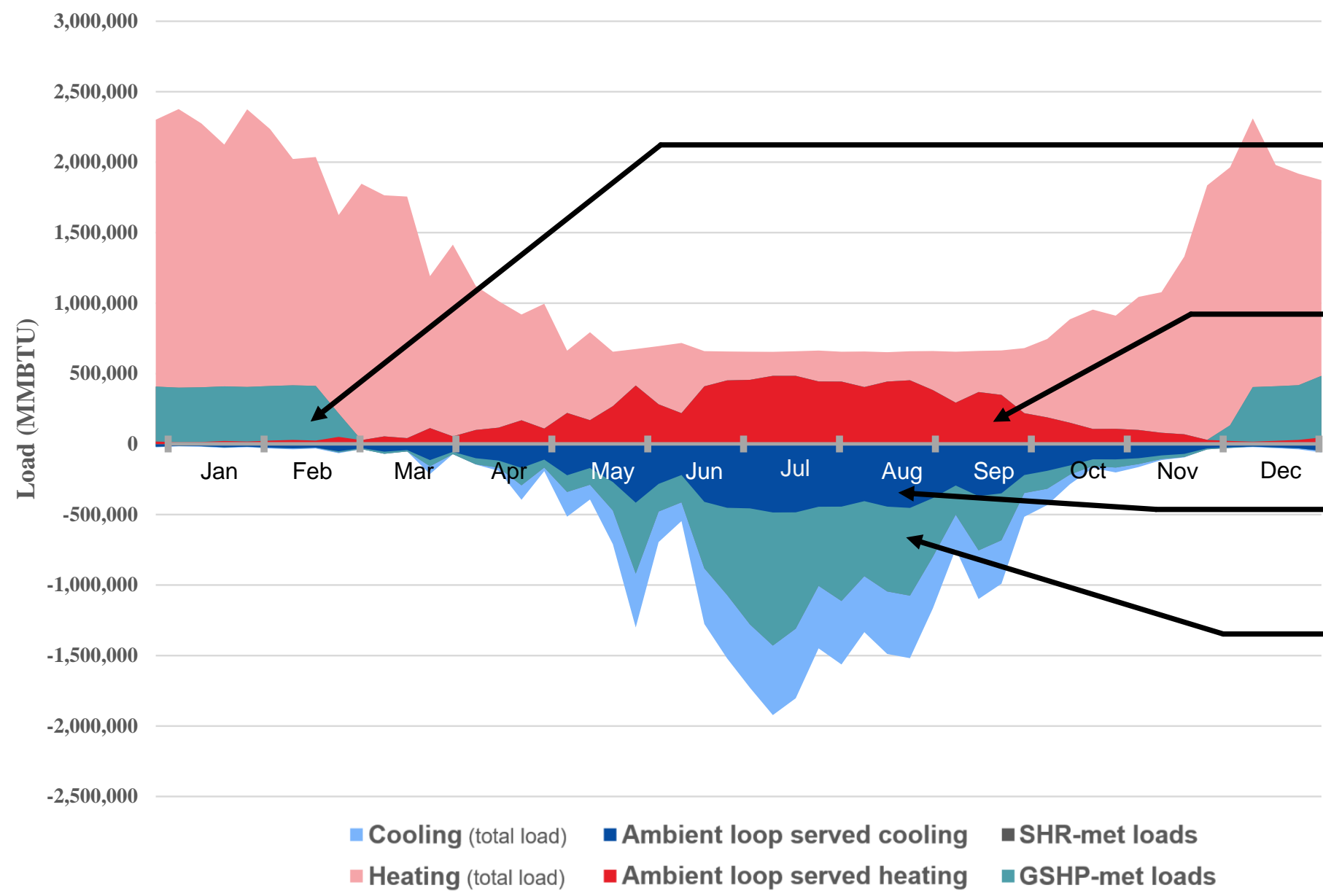

GSHP wells installed in <1 acre of available area of site coupled with Ambient Loop could meet:

GSHP: 8%
of heating loads served by ground source heat pumps (GSHP)

Ambient loop: 14%
of heating loads served by the ambient loop

Ambient loop: 35%
of cooling loads served by the ambient loop

GSHP: 37%
of cooling loads served by ground source heat pumps (GSHP)

A.7. District Energy Scenario 3

CW + Ambient Loop + Sewer Heat Recovery

A.7.1 DISTRICT THERMAL ANALYSIS

District Energy Scenario 3 System

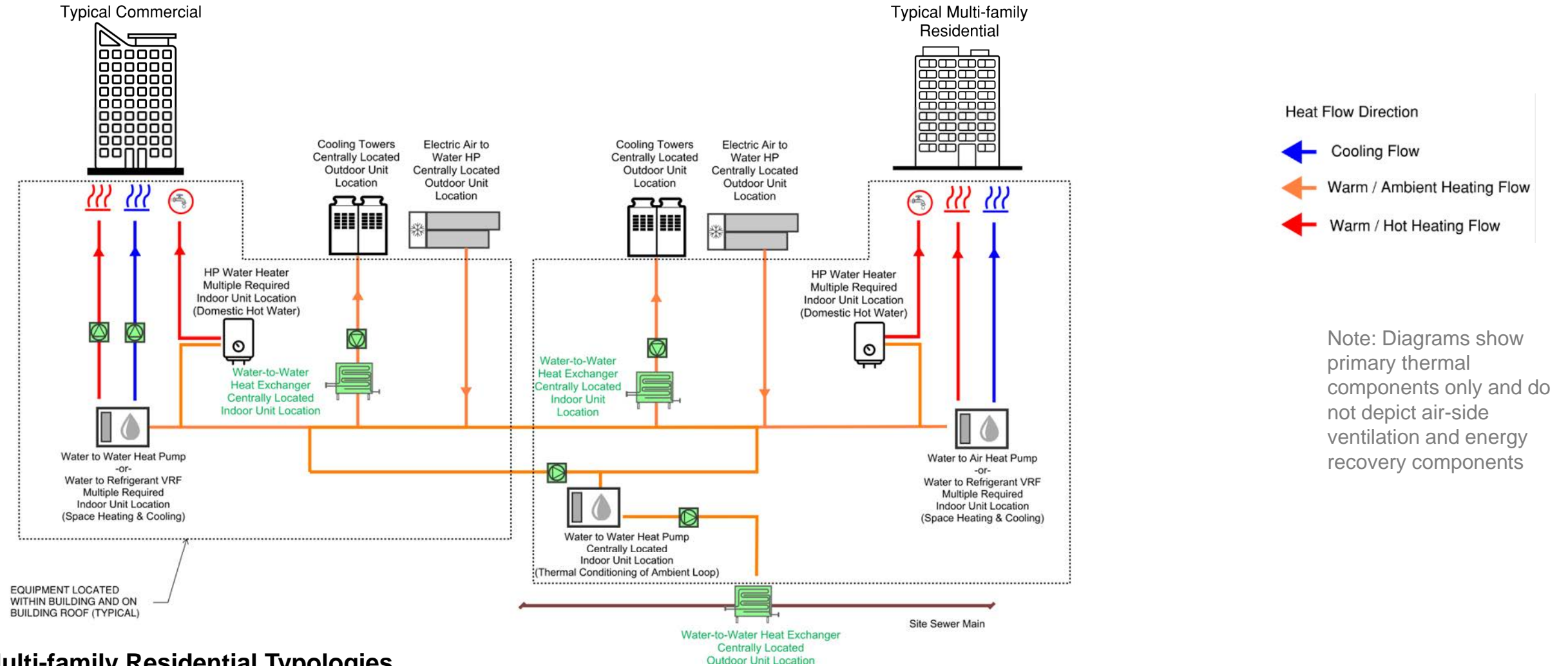

Commercial and Multi-family Residential Typologies

The **District Energy Scenario 3** system is similar to the **District Energy Scenario 1** system with the addition of a sewer heat recovery system (SHR) to supplement the Ambient Loop. A heat exchanger is inserted into the sewer main to provide another location to move heat to/from. A fluid is circulated from the sewer heat exchanger to water-to-water heat pumps to adjust (raise or lower) the temperature of the fluid in the ambient loop. The sewer heat recovery system supplements the cooling tower and air-to-water heat pumps already included.

The relatively consistent and elevated temperature of the sewer is beneficial for heating months when the outside air is very cold, and the efficiency of an air source heat pump diminishes. **The analysis is based upon a fully developed site – the overall capacity of a SHR system is diminished during the initial phases.** 28

A.7.2 DISTRICT THERMAL INTRODUCTION

Sewer Heat Recovery (SHR) System Evaluation

SHR System Assumptions

- For the purposes of this study, we have assumed the system will have all the site wastewater available at full build to use as a heat source or sink annually.
- Wastewater quantity calculations are based on those generated by typical occupancies for the assumed 80% residential 20% commercial building program using their square footages and assuming some load diversity.
- The system is assumed to be utilized for heating during the Winter months and cooling during the Summer months, factoring in differing seasonal ambient water temperatures.
- During the shoulder months (between Summer and Winter) the system can be used as either a net heating or cooling provider, depending on site demands.

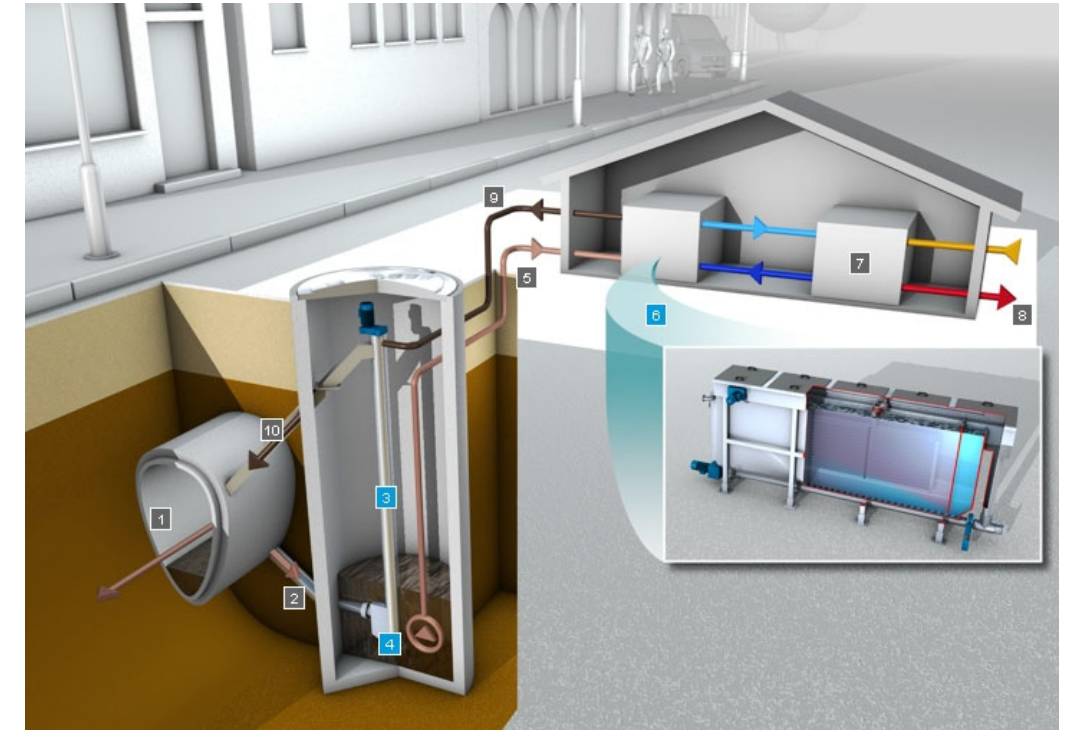
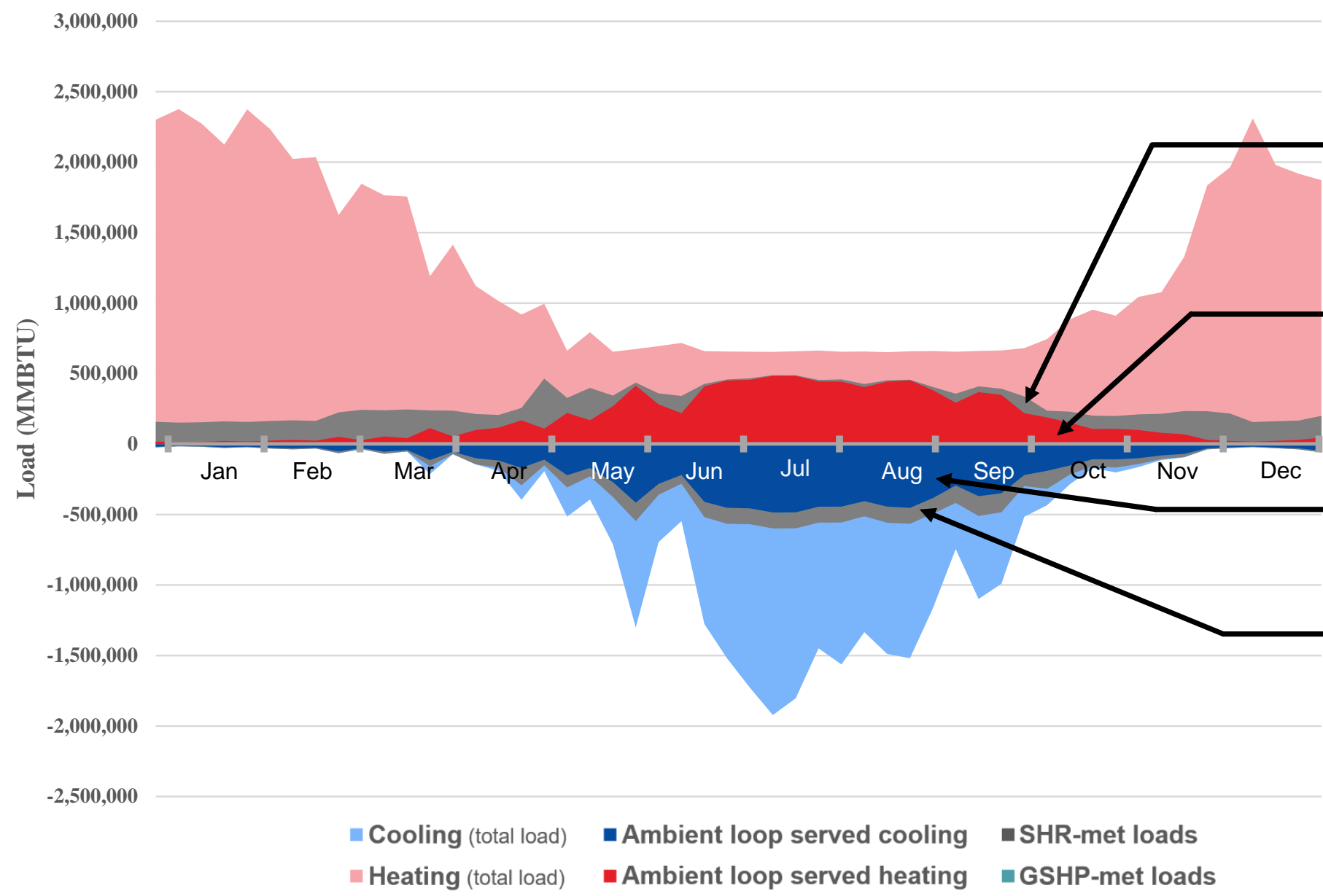

Image courtesy of Huber Technology

A.7.3 DISTRICT THERMAL ANALYSIS

District Energy Scenario 3 Potential



SHR coupled with Ambient Loop could meet:

SHR: 9%
of heating loads served by sewer heat recovery (SHR)

Ambient loop: 14%
of heating loads served by the ambient loop

Ambient loop: 35%
of cooling loads served by the ambient loop

SHR: 1%
of cooling loads served by sewer heat recovery (SHR)

A.8. District Energy Scenario 4

CW + Ambient Loop + GSHP + Sewer Heat Recovery

A.8.1 DISTRICT THERMAL ANALYSIS

District Energy Scenario 4 System

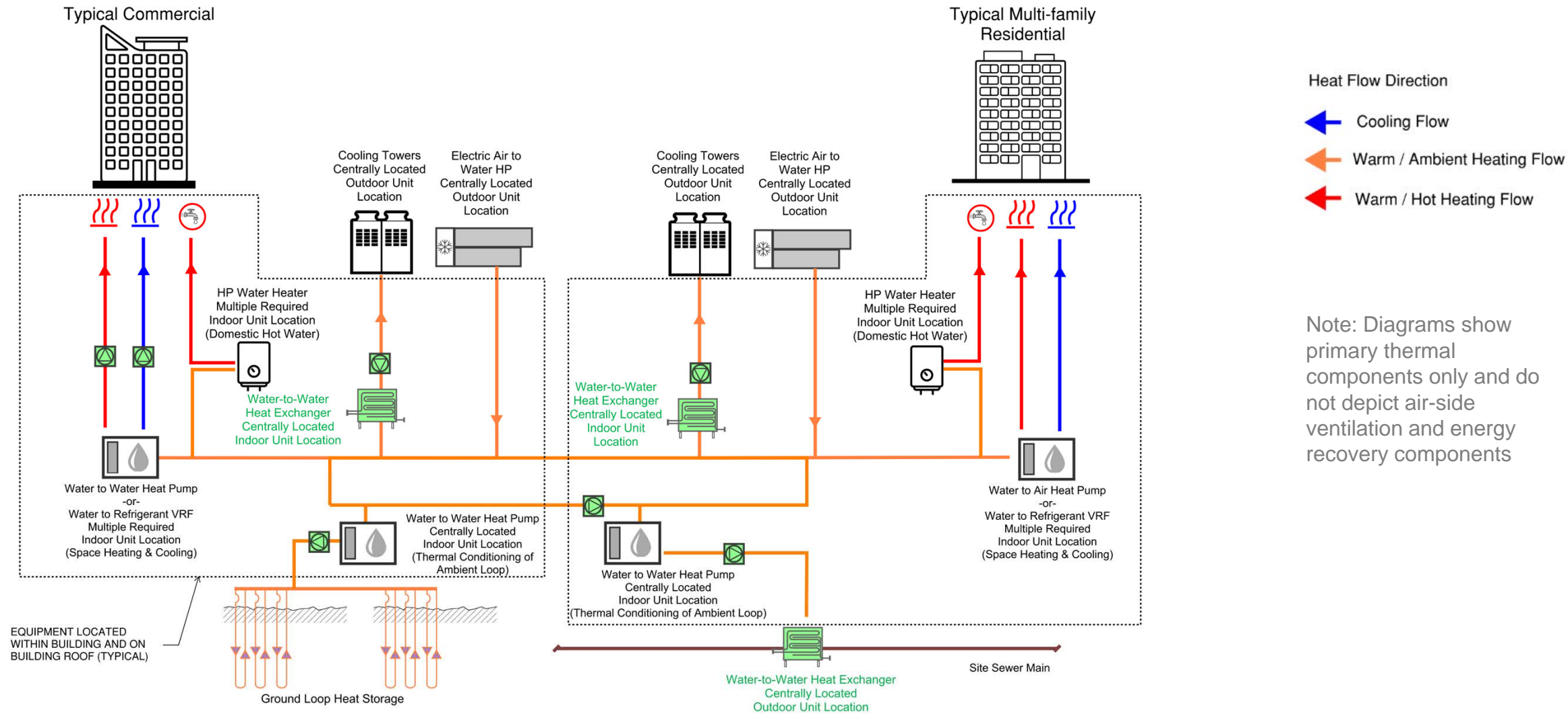

Commercial and Multi-family Residential Typologies

The **District Energy Scenario 4** system combines a GSHP system (from District Energy Scenario 2) and SHR system (from District Energy Scenario 3) to supplement the Ambient Loop (from District Energy Scenario 1).

A.8.2 DISTRICT THERMAL ANALYSIS

District Energy Scenario 4 Potential

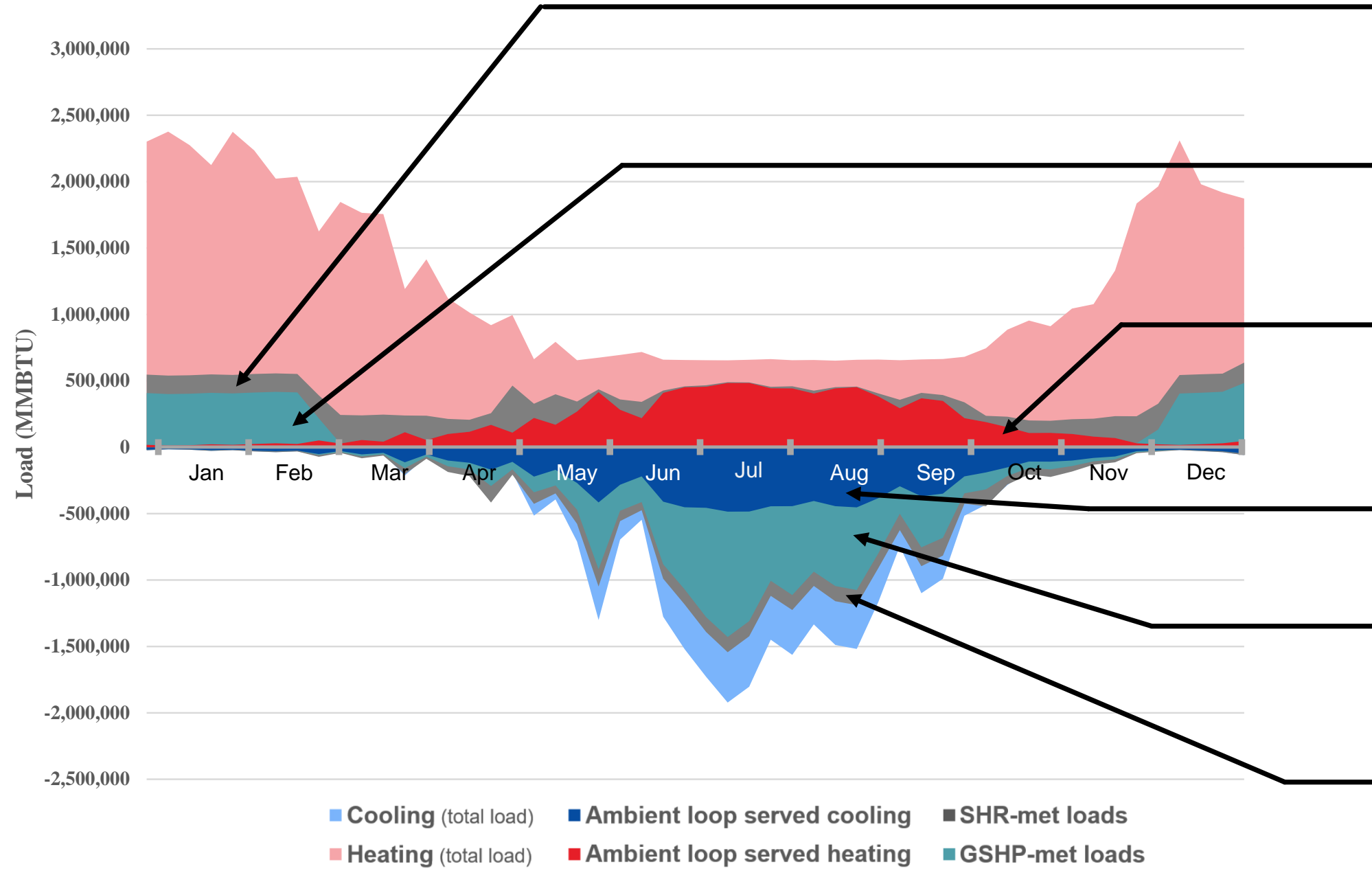

GSHP and SHR coupled with Ambient Loop could meet:

SHR: 9%
of heating loads served by sewer heat recovery (SHR)

GSHP: 8%
of heating loads served by ground source heat pumps (GSHP)

Ambient loop: 14%
of heating loads served by the ambient loop

Ambient loop: 35%
of cooling loads served by the ambient loop

GSHP: 37%
of cooling loads served by ground source heat pumps (GSHP)

SHR: 1%
of cooling loads served by sewer heat recovery (SHR)

A.8.2 DISTRICT THERMAL ANALYSIS

District Energy Scenario 4

Annual electricity consumption by technology

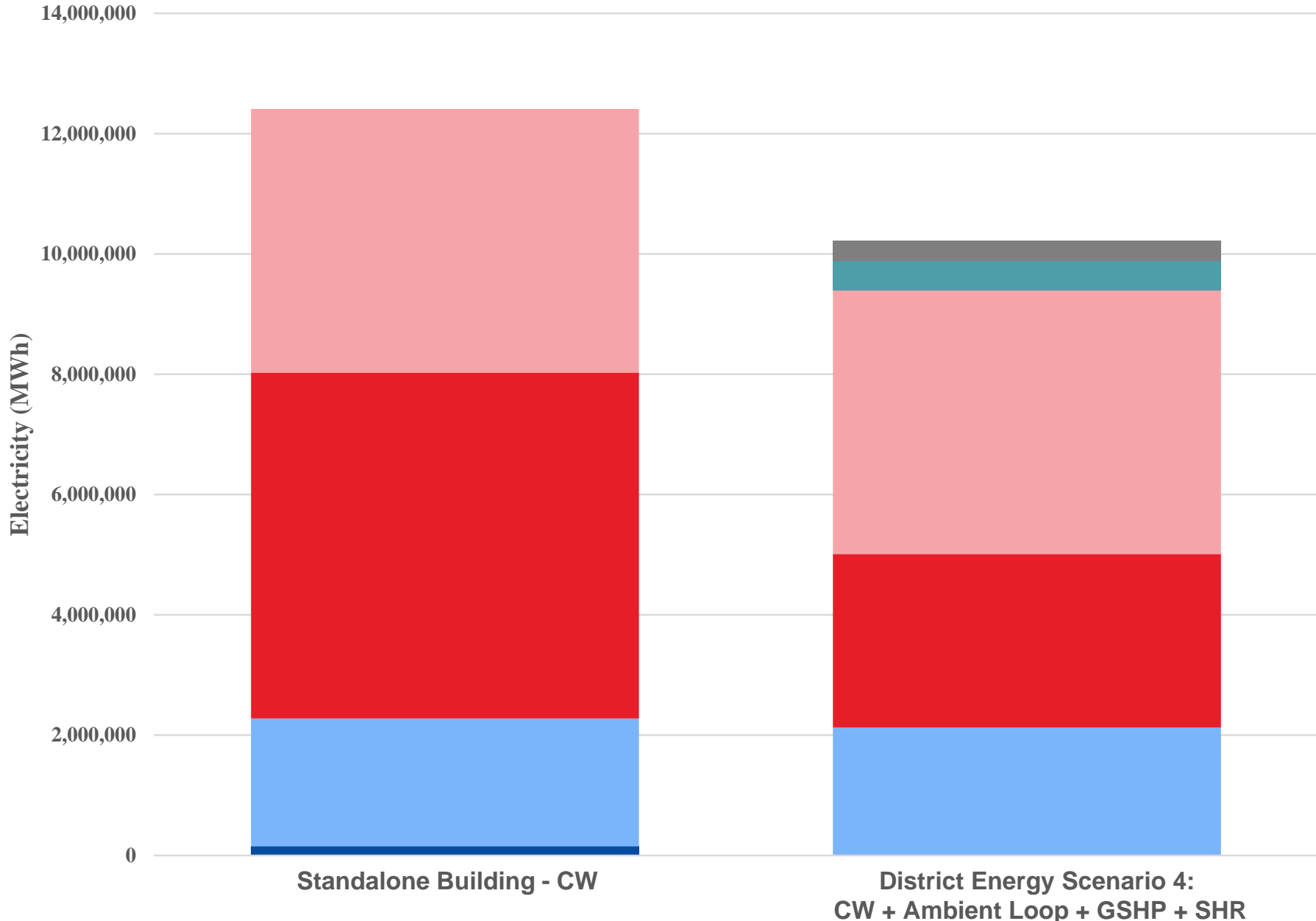

In terms of total annual electricity consumption, modest energy savings are achieved when all four (4) district energy technologies (Condenser Water Loop, Ambient Loop, Ground Source Heat Pump, and Sewer Heat Recovery) are used in combination. The SHR and GSHP technologies contribute the greatest energy-use reduction when the system is in heating mode. Because they operate at a higher efficiency, they reduce the load on the outdoor heat pumps in the standalone system. **However, the considerable added embodied carbon, complexity, and cost is detrimental to the overall analysis.**

- SHR
- GSHP
- Heating (Indoor HP)
- Heating (Outdoor HP)
- Cooling (Indoor HP)
- Cooling (Cooling Tower)

A.9 District Energy Results and Conclusions

A.9.1.1 DISTRICT THERMAL ANALYSIS RESULTS – Peak capacities

Peak heating load v. district technology peak potentials

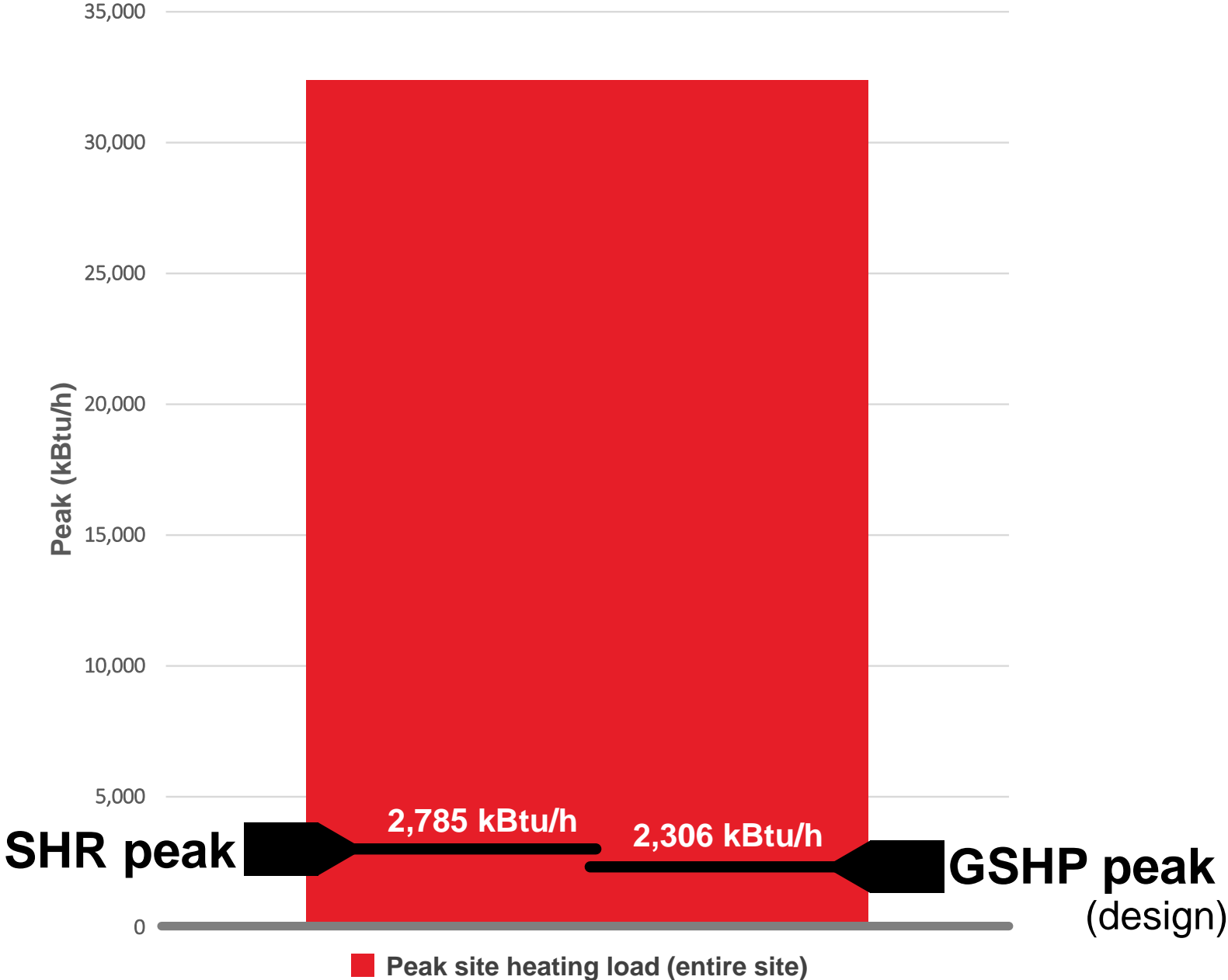

In addition to annualized heating loads, the study also analyzed peak heating loads to calculate the contribution of each of these technologies at periods of peak demand. A technology’s capacity to meet the annual heating load can vary greatly from a technology’s ability (or inability) to meet the peak heating load. For instance, a heating system may be large enough to meet the heating demand the majority of days per year (spring, summer, fall) but be too small and only able to meet a fraction of the heating demand on the coldest day of the year (the winter peak). The ability (or inability) of a district thermal system to keep pace with peak heating demands is a major determining factor of overall system feasibility.

Ground Source Heat Pump (GSHP)

The GSHP system was sized based on available site area for locating wells while factoring in various site restrictions. Only the riverfront area of the site was deemed as viable which results in a peak GSHP heat source capacity of **2,306 kBtu/h**. This is a small fraction of the peak heating capacity required for the site (~7%). While the GSHP system could improve efficiency, it adds significant embodied carbon, complexity, and cost relative to the small fraction of capacity it provides for site-wide peak heating loads.

Sewer Heat Recovery (SHR)

The peak heat source capacity of the SHR system was estimated based upon occupancy types, typical occupancy patterns and overall building areas. Peak heat source capacity was estimated to be **2,785 kBtu/h**. This is a small fraction of the peak heating capacity required for the site (~9%). While the SHR system could improve efficiency, it adds significant embodied carbon, complexity, and cost relative to the small fraction of capacity it provides for site-wide peak heating loads.

A.9.1.2 DISTRICT THERMAL ANALYSIS RESULTS – Peak capacities

Peak cooling load v. district technology peak potentials

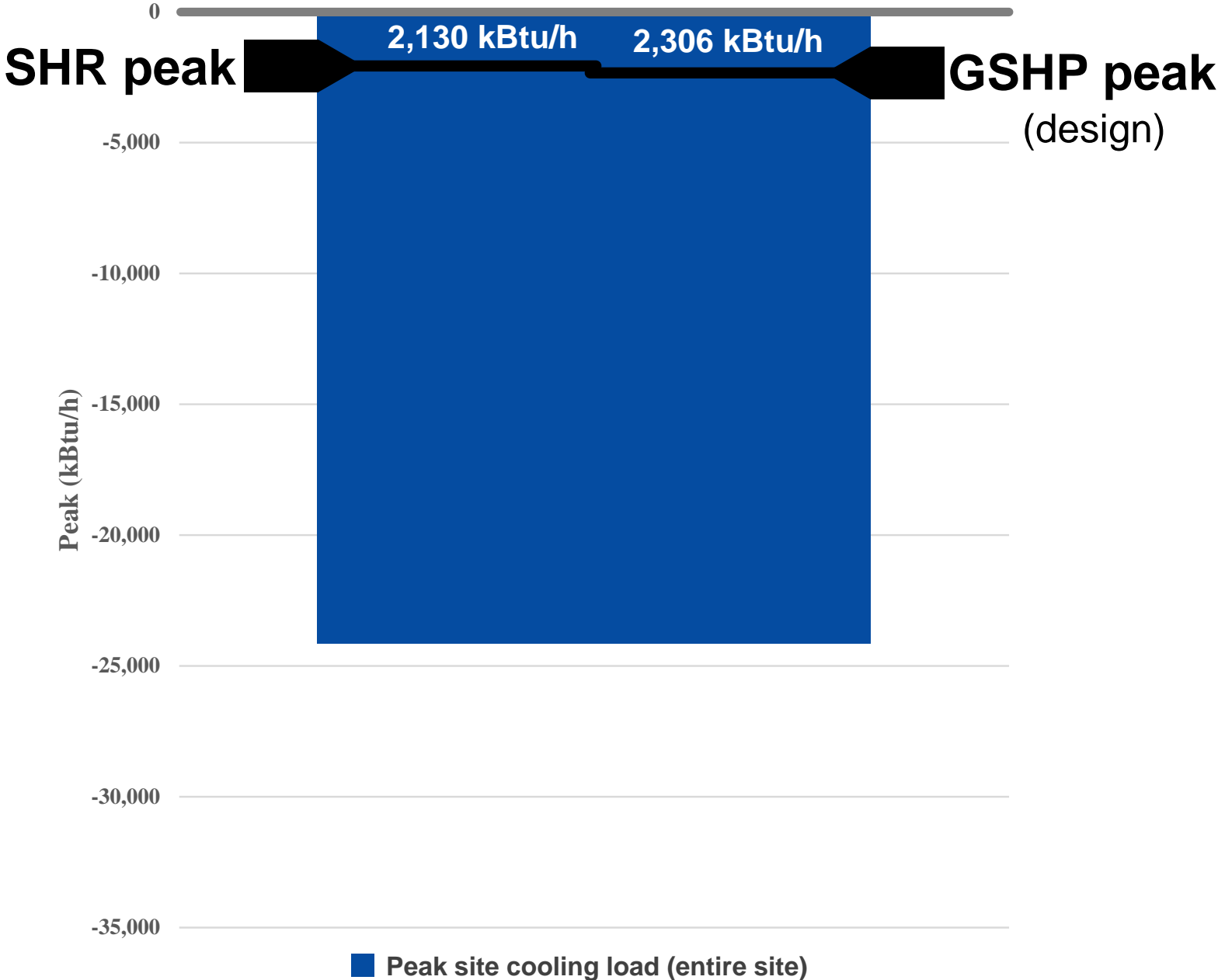

In addition to annualized cooling loads, the study also analyzed peak cooling loads to calculate the contribution of each of these technologies at periods of peak demand. A technology’s capacity to meet the annual cooling load can vary greatly from a technology’s ability (or inability) to meet the peak cooling load. For instance, a cooling system may be large enough to meet the cooling demand the majority of days per year (fall, winter, spring) but be too small and only able to meet a fraction of the cooling demand on the warmest day of the year (the summer peak). The ability (or inability) of a district thermal system to keep pace with peak cooling demands is a major determining factor of overall system feasibility.

Ground Source Heat Pump (GSHP)

The GSHP system was sized based on available site area for locating wells while factoring in various site restrictions. Only the riverfront area of the site was deemed as viable which results in a peak GSHP heat rejection capacity of **2,306 kBtu/h**. This is a small fraction of the peak cooling capacity required for the site (~9%). While the GSHP system could improve efficiency, it adds significant embodied carbon, complexity, and cost relative to the small fraction of capacity it provides for site-wide peak cooling loads.

Sewer Heat Recovery (SHR)

The peak heat rejection capacity of the SHR system was estimated based upon occupancy types, typical occupancy patterns and overall building areas. Peak SHR heat rejection capacity was estimated to be **2,130 kBtu/h**. This is a small fraction of the peak cooling capacity required for the site (~8%). While the SHR system could improve efficiency, it adds significant embodied carbon, complexity, and cost relative to the small fraction of capacity it provides for site-wide peak cooling loads.

A.9.1.3 DISTRICT THERMAL ANALYSIS RESULTS – Site Energy Use Intensity and Carbon Emissions Intensity

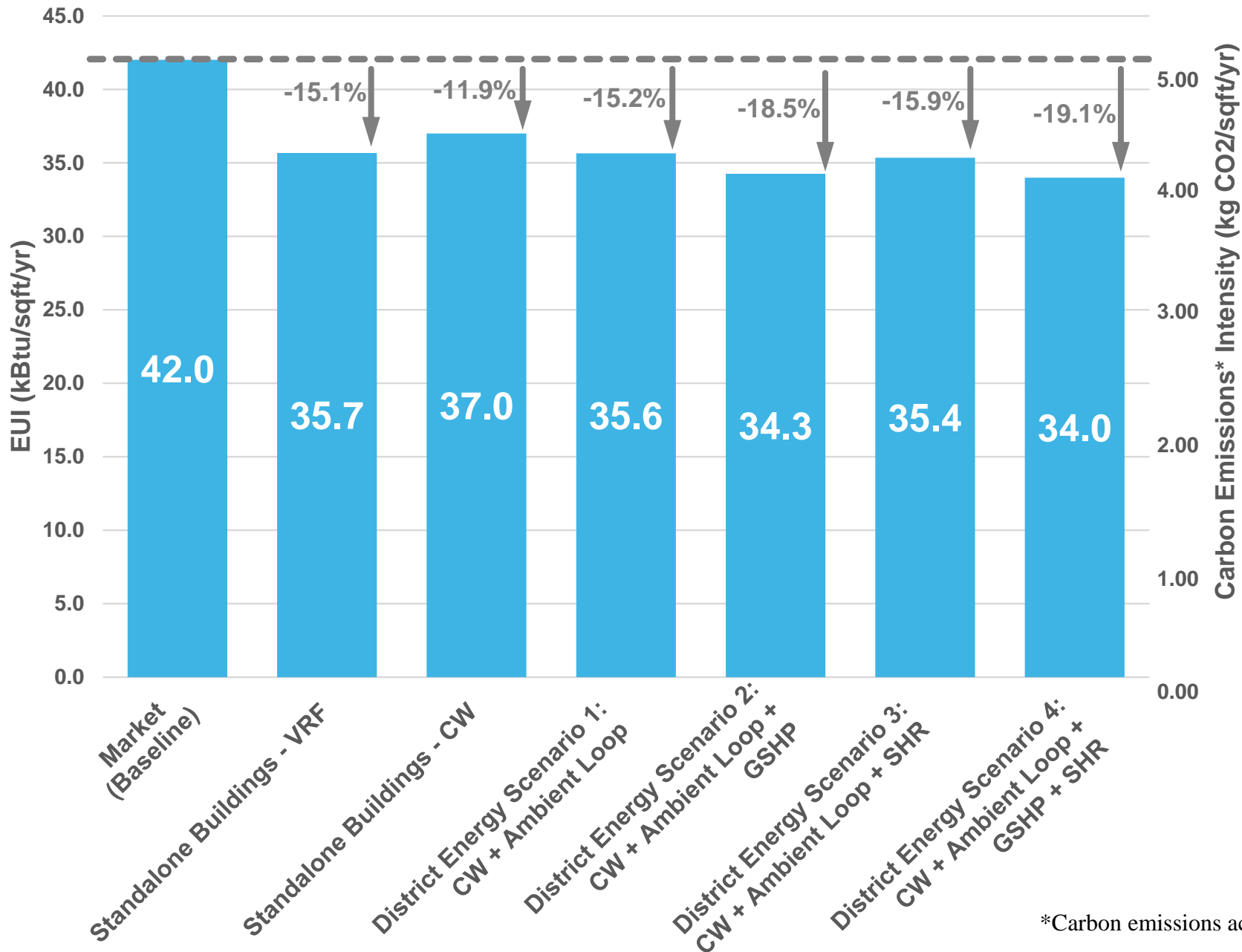

As shown on the left, the **Standalone Buildings – CRF** and **Standalone Buildings – CW** scenarios provide a 15% and 12% EUI reduction, respectively, compared to an *all-electric Market ASHRAE 90.1-206*) scenario. The various district energy system configurations provide a modest additional EUI reduction of up to 4%.

The **Standalone Buildings – VRF** and the **Standalone Buildings – CW** scenarios already benefit from efficient and electrified mechanical systems and effectively utilize waste heat within each individual building. **Of these two standalone scenarios, the Standalone Buildings – VRF is the most efficient.**

District Energy Scenario 1 provides a slight performance improvement due to increased waste heat utilization. This benefit from recovered heat is slightly diminished by additional pumping energy required to move the waste heat from one building to another (though this pumping energy accounts for less than 0.3% of total site energy consumption).

District Energy Scenario 2 provides a slight performance improvement but is limited by the available site area.

District Energy Scenario 3 provides a slight performance improvement but is limited by the available capacity of the sewer resource.

District Energy Scenario 4 combines all of the technologies together, but still only provides a slight performance improvement.

*Carbon emissions account only for operational carbon (i.e. embodied carbon is not accounted for here)

A.9.2 DISTRICT THERMAL ANALYSIS RESULTS – Construction Costs, Annual Operation & Maintenance Costs, Utility Savings

Initial capital costs to install each of the systems studied were calculated based upon pre-construction cost estimates (in 2022 dollars). While not included, unexpected cost premiums for some of these systems could also be encountered due to unforeseen conditions in redeveloping a brown-field site.

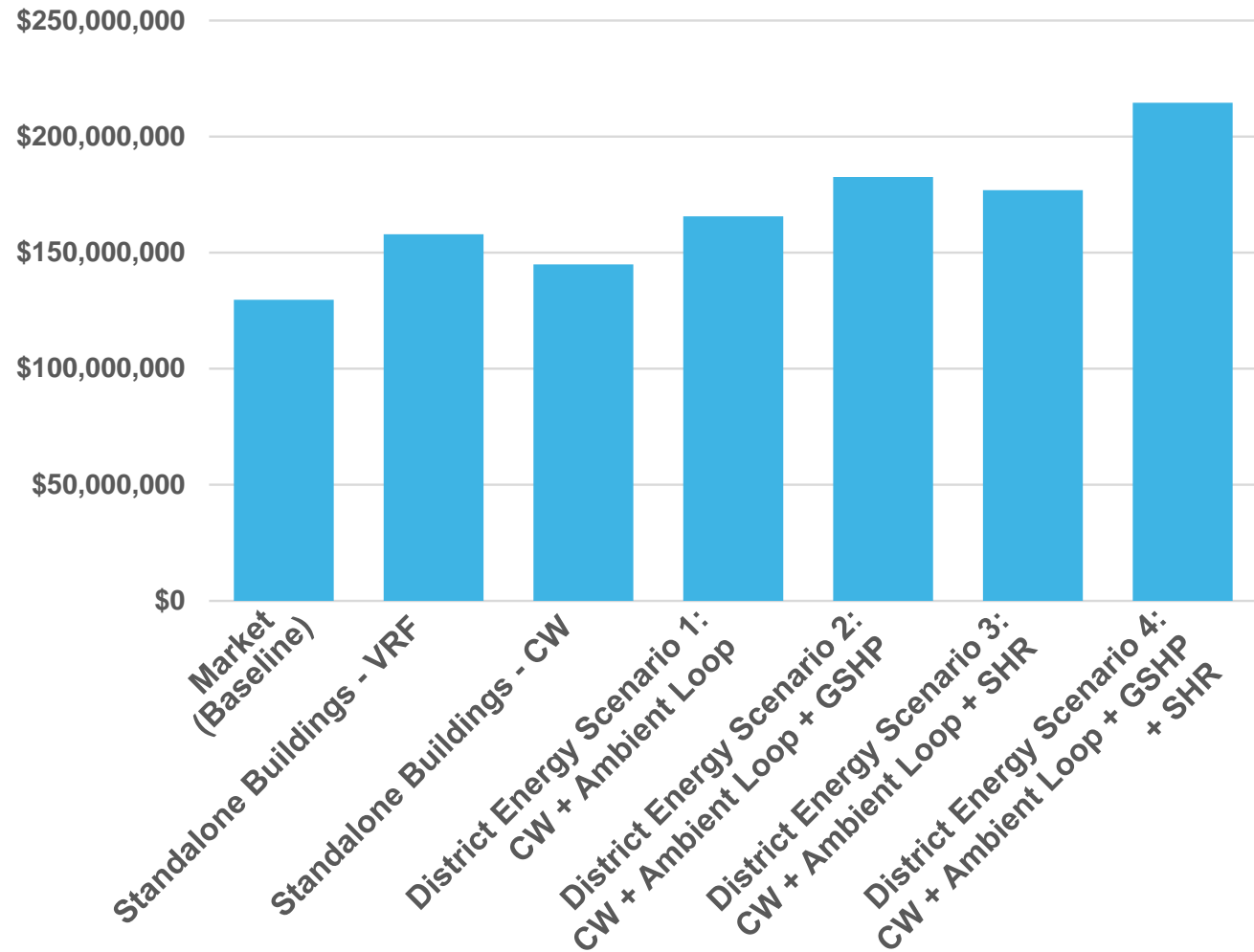

The annual operational and maintenance costs (O&M) and estimated utility savings for each of the standalone and district energy systems were also calculated. **All district scenarios have significant annual O&M premiums due to the added complexity of the systems, as does the Standalone Buildings – CW scenario. These O&M premiums exceed the utility cost savings on an annual basis, resulting in very long payback periods in exchange for the very modest energy savings shown on the prior page.**



A.9.3 DISTRICT THERMAL ANALYSIS CONCLUSION

- Less than half (46% attributed to thermal energy) of the overall site energy load would benefit from a district energy system.
- The baseline building design (Market) is already all-electric and energy efficient.
 - Both the **Standalone Buildings – CW or VRF scenarios are capable of recovering a significant amount of waste heat and waste cooling** for the site with reduced complexity.
- District Energy Scenarios 1 thru 4 offer marginal opportunities to recover additional energy beyond the **Standalone Building – CW or VRF** scenarios:
 - None of the District Energy technologies (alone or in combination) can meet the annual or peak thermal energy loads (heating or cooling).
 - **District Energy Scenario 4** only reduces the Energy Use Intensity of the buildings 4% more compared to the **Standalone Buildings - VRF**.
 - The District Energy technologies all have very long payback periods not justified by the energy they save.
- Due to significant site constraints, there is limited area (<1 acre) available for GSHPs which would only be able to meet 37% of the cooling load and 8% of the heating load. The capacity of such a GSHP system is marginal for the development.
- The SHR system could meet 9% of the annual heating load and 1% of the annual cooling load, however due to the phased nature of the development, SHR system would have limited energy recovery potential until the entire development is complete.
- The scale and complexity of a **district energy system represents significant embodied carbon emissions** (concrete structures and encasements, steel piping, plant and equipment, insulation, etc.) which far outweigh the potential carbon savings.
- **The analysis indicates that focusing on making individual building designs as efficient as possible** (e.g., high efficiency systems, maximizing viable heat recovery, envelope performance) **has a greater impact than providing a district energy system.**

A.10. Other District Technologies Assessed

A.10.1 ASSESSMENT OF RIVER WATER COOLING

Summary

Site Limitations

- The Potomac River depth is shallow at the PRGS site, which limits the amount of consistent cooling that can be pulled from the river annually.

Local Regulations

- Local regulations limit discharge from non-contact cooling water to 50,000 gallons/day which limits the capacity of the cooling system, only meeting 10% of peak cooling demand.
- The Virginia Resource Protection Area on the property prohibits building infrastructure within it and may trigger an additional water quality impact assessment application.
- National Park Service (NPS) owns the land adjacent to the Potomac River, and the system would require additional NPS approval.

Environmental Concerns

- River water cooling systems can create environmental concerns by pulling fish and other river wildlife into the cooling system.
- The US EPA regulates Cooling Water Intake Systems and requires a source water baseline biological characterization study.

As described in more detail on the following page, due to these limitations, river water cooling is not considered a viable alternative for the PRGS project.



A.10.1 ASSESSMENT OF RIVER WATER COOLING

System Limitations

Site Limitations

River water cooling was considered for this site. Unlike deeper waters in a lake, river water temperatures vary throughout the course of a year. In the Potomac River, water temperature varies from 32 to 92 degrees F. The Potomac River adjacent to the PRGS site ranges from 3-8 feet in depth outside of the Alexandria Channel and from 25-32' in depth within the Alexandria Channel. The channel is approximately 400' from the PRGS shoreline. Successful river water cooling systems are located adjacent to bodies of water that can provide consistently cool temperatures year-round, typically at least 100' deep.

Local Regulations

The Virginia Department of Environmental Quality issues Pollutant Discharge Elimination System (NPDES) Permits. They have general requirements surrounding Non-Contact Cooling Water Discharges, limited to **50,000 gallons/day** or less. Preliminary peak cooling loads for the development are 38,372 kBtu/hour. If the daily discharge of 50,000 gallons occurred in an hour (833 gpm), assuming a temperature delta of 10 degrees, this would result in 4,166 kBtu/hour of cooling, less than 10% of the peak cooling load. Additionally, the temperature of the discharge may not exceed 32 degrees C, and the effluent shall not increase the temperature of the receiving stream more than 3 degrees C above the natural water temperature.

Environmental Concerns

A river-water cooling system includes a large water intake and filtration system to clean water to be used for cooling. This would typically include a coarse screen filter on the intake itself to prevent fish from being sucked into the system, and additional chemical and physical filtration downstream of the intake. Despite these filters, it is common for fish, shellfish, and their eggs to be pulled into a cooling system. River water tends to have elevated levels of sediment that decrease longevity of the cooling system and require significant and consistent maintenance.

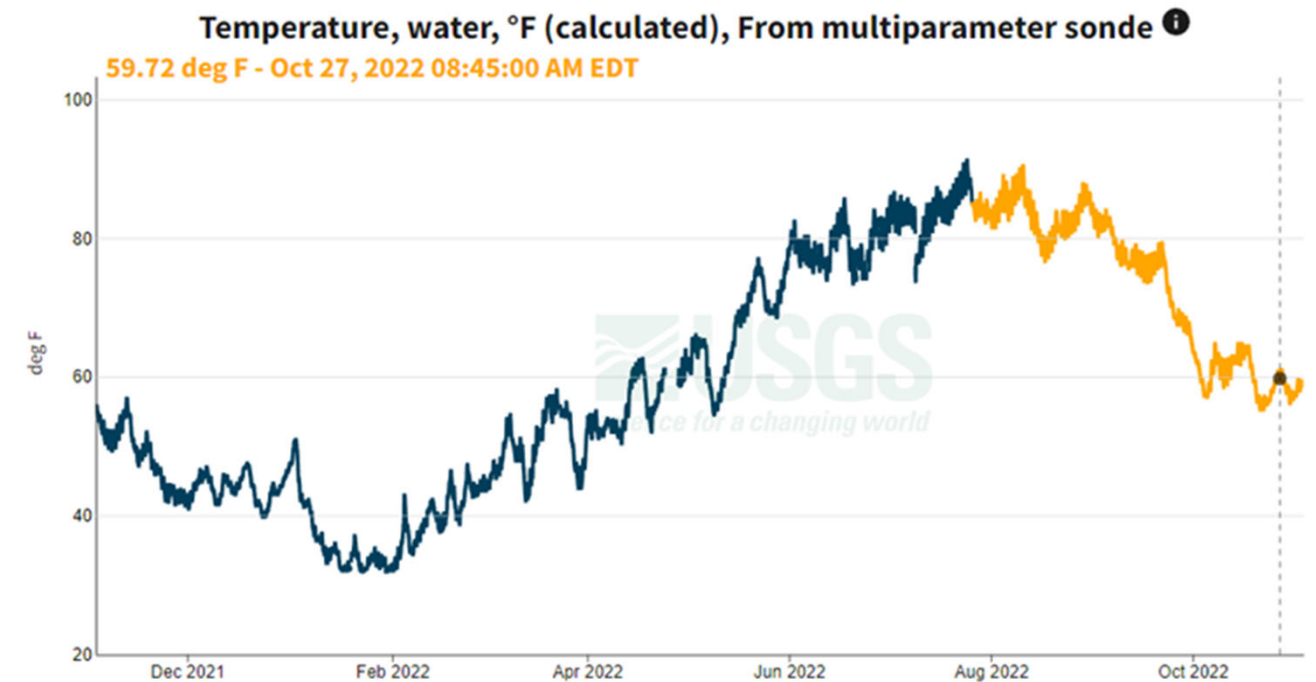

Source: *USGS Little Falls Pump Station*

A.10.2 ASSESSMENT OF ANAEROBIC DIGESTION

Summary

The Alexandria Old Town North Small Area Plan stipulated analysis of anaerobic digestion for the PRGS site. **It is not feasible for the following reasons: (1) minimal onsite generation of available feedstock, (2) space limitations to provide a federally compliant location and (3) ongoing operational demands and combustion.**

System Limitations

System Capacity

Food waste at the site would be the feedstock for an anaerobic digester. An estimate of 3.5 tons/day of food waste results in a potential 320 MWh/year of biogas production, which is extremely minimal compared to overall site demand of 30,000 MWh.

Site Limitations

Federal recommendations surrounding anaerobic digesters stipulate locating the digester outside of the 100-year floodplain [1] and “as far from neighboring dwellings or public areas as practicable” [2]. While the PRGS site is not subject to significant flood risk [3], the project includes acres of public area for public use, as well as many housing units. The feasibility of locating a digester within a reasonable distance with vehicular access for maintenance while maintaining appropriate distances from public spaces and residences is unlikely.

Permitting Concerns

Anaerobic digesters are considered a waste processing facility and require Full Solid Waste Permits for construction and operation of waste disposal facilities. Additional air and water quality permits are also required.

Staffing & Cost Concerns

Anaerobic digesters are not turnkey systems, they require plant management and expertise with an entire dedicated staff for maintenance and operations. These systems at minimum require pre-processing equipment, buffer tank, mixers, digestion tank, post digestion tank, gas collection equipment, and program design. Overall system upfront and operational costs and space allotment have not been included in development plans.

Environmental Concerns

The combustion of biogas has resulting emissions and pollution that would need to be mitigated from the site.

[1] Standard Federal Practices - Anaerobic Digester

[2] Conservation Practice Standard Anaerobic Digester

[3] FEMA Floodplain Alexandria

Part B.

Microgrid Feasibility Analysis

B.1. DISTRICT ENERGY MICROGRID FEASIBILITY

District Energy Microgrid

A **District Energy Microgrid** is an energy system for clusters of buildings. It produces electricity on site and uses excess heat to serve heating/cooling demands, increasing overall energy efficiency. **BESS** (Battery Energy Storage System) solutions allow the supply of backup power by using a group of batteries to store electrical energy.

These systems normally operate connected to the main electric utility grid but can disconnect (“**island**”) during power outages and continue to provide electricity, heating and cooling for building users. The microgrid analysis considered an estimated annual site energy demand of 30,000 MWh for the site.

- To provide battery backup to the entire project for 2 hours in case of a power outage, a BESS system would need to provide 3.4 MW for 2 hours, or about 7 MWh.
- Providing full site backup for 2 hours would require 2 Tesla Megapacks, costing about \$1,000,000 each for the equipment plus installation and connection costs. The space required for one is approximately 25' x 10'.
- In order to backup only a critical load percentage (20%) of the development for 2 hours, a BESS system would need to provide 1.3 MWh. This translates to capital costs of approximately \$350/kWh, or \$500,000.



B.2. PV + BESS OVERALL ENERGY CONTRIBUTION

Analysis of Development Microgrid

PV will power the on-site microgrid considered in this analysis generating 3% of the site's annual energy demand. The battery energy storage system analyzed would be connected to the PV system.

Assuming the 3% requirement is able to be met on site, the entire PV system capacity will generate 900 MWh annually. Assuming a 1400 kWh/kw system efficiency, the entire PV system capacity will need to be approximately 650 kW.

BESS sizing considers the size of on-site PV with a battery selected to meet that power rating. The discharge duration at the 650kW rating is taken to be a 4-hr discharge duration, meaning that the battery can maintain its output for 4 hours during a grid interruption. The overall BESS size is approximated as having 2.5 MWh to store the PV system's capacity.

PV Energy Contribution

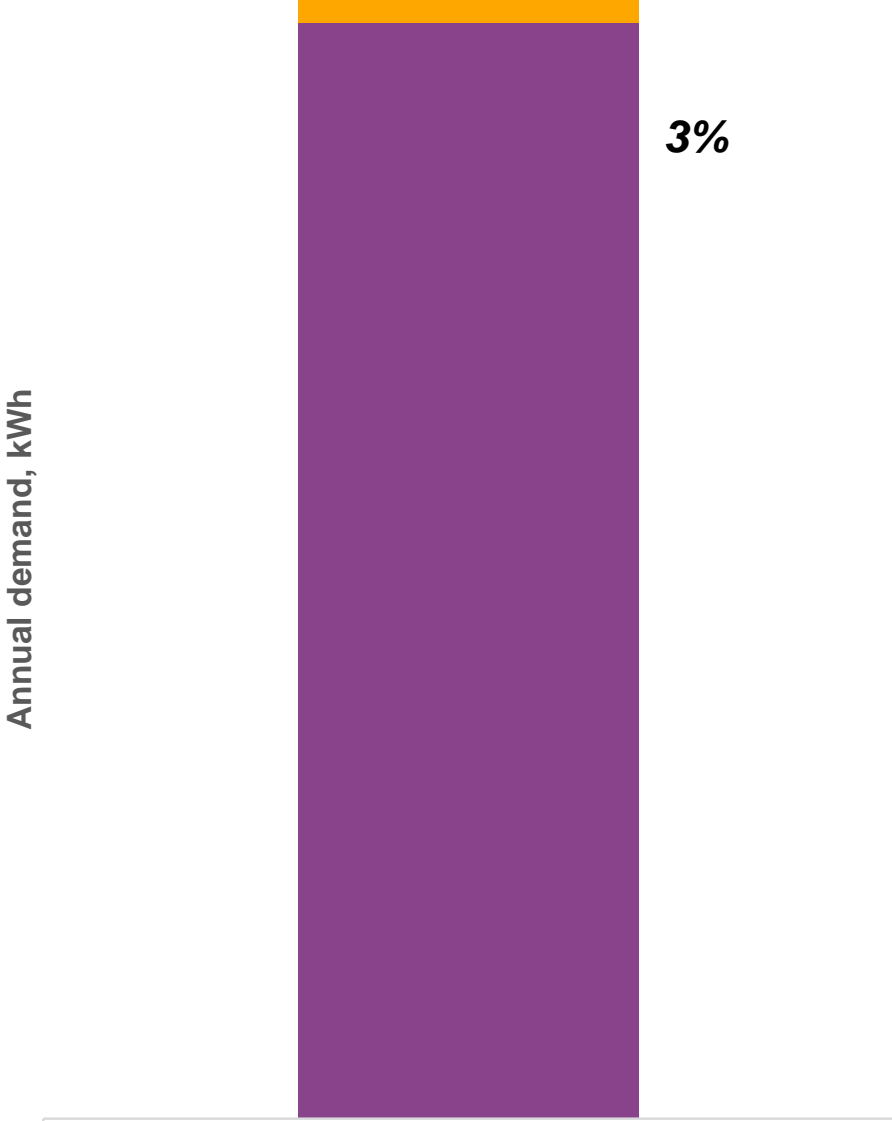

B.3.1 ROOFTOP ANALYSIS CONSIDERATIONS

CDD Required PV Production

Targets

Offset 3% of annual site energy: ~30,000 MWh

PV offset: ~900 MWh

Panel Orientation Analysis

- 4 panel orientation explored to understand panel efficiency
- Horizontal panels should be prioritized followed by vertical S facing and SW facing, respectively, if financially feasible
- Vertical W facing panels should not be considered due to lower efficiency, longer payback, customized mounting systems and prioritization of responsible use of raw materials used in PV panels. Hence Vertical W panels were excluded from any further analysis

Panel Orientation	Average kWh/kWp	Efficiency Drop
Horizontal - 10° Tilt	1,400	-
Vertical – S Facing	1,050	25%
Vertical – SW Facing	950	33%
Vertical – W Facing	700	50%

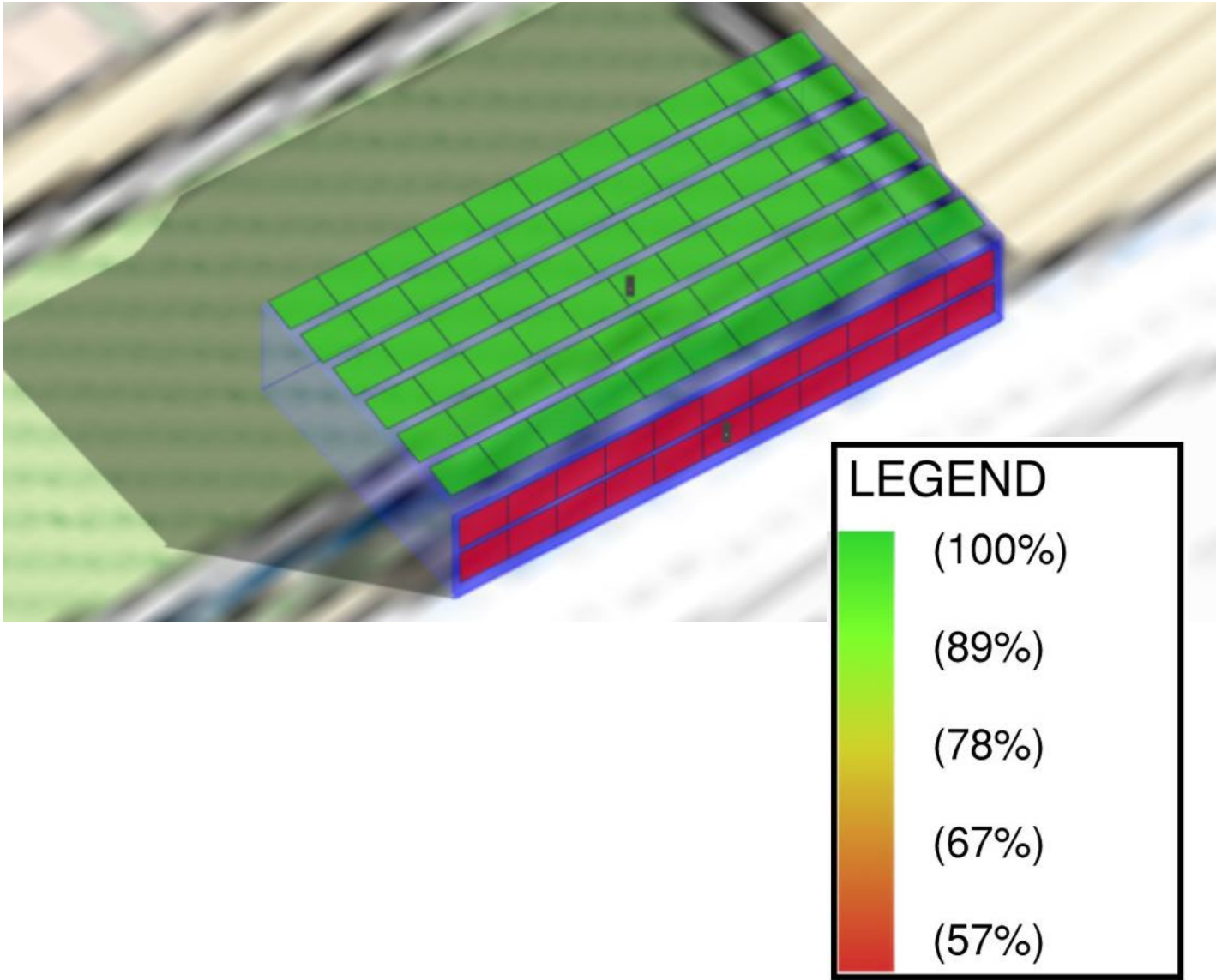

B.3.2 ROOFTOP ANALYSIS CONSIDERATIONS

Block Rooftop PV Estimates

Rooftop PV Total Area	
Block	Area (sf)
A	-
B	7,000
C	8,870
D	3,000
E	8,850
F	10,600

Layout	System Size (kW)	Annual Energy (MWh/yr)	Output Efficiency (kWh/kW)
Horizontal Rooftop	459	623	1400
Additional Capacity	TBD	277	TBD

Rooftop PV Contribution: 623 MWh/year (~2% site energy)

*Additional capacity will be refined as block and site design continues



B.4. MICROGRID FEASIBILITY CONCLUSIONS

Currently, many microgrids still rely on natural gas or diesel generators. In line with the project's all-electric commitments only clean energy sources were evaluated for this microgrid study. It should also be noted that standard electricity pricing at the location does not have time of use (peak demand) pricing.

This size BESS is considered small for microgrid implementation. Procurement of small-scale BESS systems is challenging due to availability of components, and operational resilience benefits would be minimal. Without life-critical demands like healthcare, small-scale BESS system aren't recommended for the project site.

In conclusion, it is not recommended that the development pursues installation of a BESS in the first phase. The battery storage and on-site generation technologies should be re-evaluated in future timeframes to account for further advancements, price changes and incentives.

Learn More: [HRP Alexandria](#)